

BC Range

Glass Door Merchandisers



Features and Benefits

- * Fan Assisted Cooling
- * Adjustable Temperature
- * Switchable Internal Light
- * Lock
- * Adjustable Shelving (BC60 Only)
- * Self Closing Door
- * Adjustable Feet
- * Door Not Reversible

Technical Specifications

Temperature Range . . . +3/+10°C

Refrigerant R134A

Type of Defrost Manual

No. of Shelves

BC30 1

BC60 2

Exterior Finish Black

Interior Finish Black

Power Required 13 Amp Supply



BC30



2 Shelves supplied



BC60

Dimensions	Height:	Width:	Depth:	Weight:	Capacity:
External					
BC30	475mm	356mm	406mm	23kg22ltr. (0.78cu.ft.)
BC60	650mm	432mm	496mm	36kg67ltr. (2.37cu.ft.)
Internal					
BC30	375mm	278mm	213mm		
BC60	550mm	350mm	280mm		

MODEL	Description	Price	MODEL	Description	Price
BC30	Black	£288	BC60	Black	£321

CHILLED DISPLAY

EM 80

Glass Door Merchandiser



EM 80 Wine



EM80 supplied with 3 shelves as standard to maximise display space

Features and Benefits

- * Double Glazed Doors
- * Adjustable Shelving
- * Branding Available
- * Static Cooling
- * Smoked Glass Door as Standard on Wine Version
- * Switchable Interior Light
- * Digital Temperature Display (not on wine version)
- * Wine Version Holds 18x75cl Wine Bottles
- * Door Not Reversible
- * Adjustable Temperature

Technical Specifications

Temperature Range	+6/+10°C
Refrigerant	R134A
Type of Defrost	Off cycle
No. of Shelves	Standard 3 Wine 3
Exterior Finish	White/Grey Dark Brown (wine cabinet)
Interior Finish	White
Power Required	13 Amp Supply



EM 80



Dimensions	Height:	Width:	Depth:	Weight:	Capacity:
External					
EM 80	780mm	506mm	565mm	34kg	92ltr. (3.24cu.ft.)
Internal					
EM 80	620mm	420mm	390mm		

MODEL	Description	Price	MODEL	Description	Price
EM 80	White	£315	EM 80 Wine	Brown	£379

BC145

Glass Door Merchandiser

Features and Benefits

- * Fan Assisted Cooling
- * Switchable Interior Light
- * Adjustable Shelving
- * Easy Clean Interior
- * Double Glazed Door
- * Adjustable Feet
- * Lock Fitted as Standard
- * Adjustable Temperature
- * Curved Profile Door

Technical Specifications

Temperature Range . +4/+10°C
Refrigerant R134A
Type of Defrost Manual
No. of Shelves 3
Exterior Finish White
Interior Finish White
Power Required 13 Amp Supply



Supplied with three shelves

Dimensions	Height:	Width:	Depth:	Weight:	Capacity:
External					
BC145	850mm	506mm	565mm	38kg	125ltr. (4.4cu.ft.)
Internal					
BC145	705mm	420mm	400mm		

MODEL	Description	Price
BC145	White	£344

HGN 100

Glass Door Merchandiser

Features and Benefits

- * Fan Assisted Cooling
- * Double Glazed Doors
- * Reversible Door (factory option)
- * Adjustable Shelves
- * Switchable Interior Light and Illuminated Canopy
- * Adjustable Temperature

Technical Specifications

Temperature Range . +2/10°C
Refrigerant R134A
Type of Defrost Off Cycle
No. of Shelves 2
Exterior Finish White
Interior Finish White
Power Required 13 Amp Supply



Dimensions	Height:	Width:	Depth:	Weight:	Capacity:
External					
HGN 100	790mm	480mm	518mm	40kg	77ltr. (2.72cu.ft.)
Internal					
HGN 100	550mm	395mm	305mm		

MODEL	Description	Price
HGN100	White	£433

CHILLED DISPLAY

UR150 Range

Glass Door Merchandiser



Features and Benefits

- * Fan Assisted Cooling
- * Reversible Door
- * Adjustable Temperature
- * Adjustable Shelving
- * Lock
- * Switchable Interior Light
- * Digital Temperature Display

Technical Specifications

Temperature Range +2/+4°C
Refrigerant R134A
Type of Defrost Off Cycle
No. of Shelves 3
Exterior Finish
UR150G White
UR150GSS Stainless Steel
Interior Finish White
Power Required 13 Amp Supply

Dimensions	Height:	Width:	Depth:	Weight:	Capacity:
External					
UR150G	820mm	600mm	600mm	38kg	146ltr. (5.15cu.ft.)
Internal					
UR150G	685mm	515mm	415mm		

MODEL	Description	Price	MODEL	Description	Price
UR150G	White	£488	UR150GSS	Stainless Steel	£552

PR14

Glass Door Merchandiser



Features and Benefits

- * Fully Automatic
- * Fan Assisted Cooling
- * Adjustable Temperature
- * Switchable Interior Light
- * Adjustable Feet
- * Stainless Steel or White Finish
- * Lock Fitted as Standard
- * Temperature Display
- * Adjustable Shelves

Technical Specifications

Temperature Range +3/+8°C
Refrigerant R134A
Type of Defrost Automatic
No. of Shelves 2
Exterior Finish
PR14 White
PRX14 Stainless
Interior Finish
PR14 White
PRX14 Stainless
Power Required 13 Amp Supply

Dimensions	Height:	Width:	Depth:	Weight:	Capacity:
External					
PR14	840mm	604mm	615mm	43kg	156ltr. (5.5cu.ft.)
Internal					
PR14	694mm	524mm	450mm		

MODEL	Description	Price	MODEL	Description	Price
PR14	White	£758	PRX14	Stainless Steel	£807

CHILLED DISPLAY

Libra Range

Glass Door Merchandiser

Features and Benefits

- * Fully Automatic Operation
- * Replaceable Door Gasket
- * Lock Fitted as Standard
- * Digital Thermometer
- * Fan Assisted Cooling
- * Adjustable Shelving
- * Reversible Door (P.O.A.)
- * Stainless Steel or White Exterior
- * Switchable Internal Light
- * Adjustable Temperature
- * Solid Door Chiller on Page 111
- * Solid Door Freezer on Page 153/154

Technical Specifications

Temperature Range . . . 0/+5°C
Refrigerant R134A
Type of Defrost Off Cycle
No. of Shelves 2
Exterior Finish White or
 Stainless Steel
Interior Finish White
Power Required 13 Amp Supply



CAR 175G



CAR 175SG



Dimensions	Height:	Width:	Depth:	Weight:	Capacity:
External					
CAR 175G	850mm	592mm	650mm	55kg	155ltr. (5.5cu.ft.)
Internal					
CAR 175G	725mm	518mm	440mm		

MODEL	Description	Price	MODEL	Description	Price
CAR175G	White/Glass Door	£599	CAR175SG	Stainless/Glass Door	£668

Super 5

Glass Door Merchandiser

Features and Benefits

- * Fully Automatic Operation
- * Interior Light
- * Fan Assisted Cooling
- * Double Glazed Door
- * Reversible Door
- * Adjustable Shelving
- * Adjustable Feet
- * Branding Available
- * 192 x 330ml Can Capacity
- * Adjustable Temperature

Technical Specifications

Temperature Range . . . +2/+10°C
Refrigerant R134A
Type of Defrost Off Cycle
No. of Shelves 2
Exterior Finish White, Black
Interior Finish White
Power Required 13 Amp Supply



SUPER 5 White



SUPER 5 Black



Dimensions	Height:	Width:	Depth:	Weight:	Capacity:
External					
SUPER 5	870mm	500mm	580mm	40kg	125ltr. (4.42cu.ft.)
Internal					
SUPER 5	750mm	420mm	400mm		

MODEL	Description	Price	MODEL	Description	Price
SUPER 5	White	£646	SUPER 5	Black	£646

CHILLED DISPLAY

TFW Range

Wine Cooler

Features and Benefits

- * Fan Assisted Cooling
- * Fully Automatic
- * Wooden, Drawer Type Shelves for Easy Access
- * Digital Temperature Display
- * Adjustable Temperature so Suitable for White or Red Wine (TFW360-2 is Dual Compartment)
- * Switchable Orange LED Interior Lighting (no bulbs to replace)
- * Lock Fitted as Standard on TFW370 & TFW360-2
- * Reversible Door

Technical Specifications

Temperature Range. +5/+12° or +12/+18°C

Refrigerant R134A

Type of Defrost Automatic

No. of Shelves

TFW80S Base +5

TFW160S Base +3

TFW370S Base +15

TFW360-2 Base + 6 + 7

Exterior Finish Black (stainless door frame on TFW80W and TFW160S)

Interior Finish Black

Power Required 13 Amp Supply



TFW370

Up to 168 bottles



TFW160S

Up to 42 bottles



TFW80S

Up to 18 bottles



TFW360-2

Up to 155 Bottles
77 top
78 bottom

Dual Temperature
White Wine Top
Red Wine Bottom

New product



Layout of bottles on TFW160S Shelf



Slide out wine shelves

Note: Different designs/shape of 75cl wine bottle may affect how many bottles can be stocked in unit.

Dimensions	Height:	Width:	Depth:	Capacity:
External				
TFW80S	860mm	295mm	570mm	18x75cl bottles
TFW160S	820mm	595mm	570mm	42x75cl bottles
TFW370/TFW360-2	1800mm	595mm	695mm	168x75cl bottles
Internal				
TFW80S	610mm	225mm	430mm	
TFW160S	605mm	525mm	515mm	
TFW370	1590mm	515mm	530mm	
TFW360-2 (Top)	763mm	515mm	530mm	
TFW360-2 (Bottom)	772mm	515mm	530mm	

MODEL	Description	Price	MODEL	Description	Price
TFW80S	Black	£378	TFW370	Black	£863
TFW160S	Black	£521	TFW360-2	Black (Dual Temperature)	£969

Ice Range

Ice Makers



Features and Benefits

- * Clear Cubed Ice
- * Fully Automatic Operation
- * Stainless Steel Exterior (Galvanised Rear)
- * Adjustable Feet
- * Minimum Water Temperature 5°C

Technical Specifications

Operating Range Not suitable for Ambient less than 10°C or more than 32°C

Refrigerant R134A

Type of Defrost Hot gas

Water Consumption

Ice-One 110ltr @ 15°C

Ice-Three 144ltr @ 15°C

Exterior Finish Stainless Steel (Galvanised Rear)

Interior Finish Plastic

Power Required 13 Amp Supply



Ice-One



Ice-Three



We recommend the use of an in-line filter with all Interlevin ice machines, this will help reduce lime scale build up and improve the efficiency and overall lifespan of the unit. Breakdowns associated to lime scale problems are not covered under Warranty.

In Line Filters	
AP3S Kit (Ice One)	£125
HF20S Kit (Ice Three)	£175
Replacement Filters	P.O.A.

Dimensions	Height:	Width:	Depth:	Weight:	Kg/24Hr (Max):	Bin Capacity:
Ice-One	738mm	457mm	523mm	39kg	.25 (1250 cubes)	14kg
Ice-Three	790mm	457mm	523mm	44kg	.38 (1900 cubes)	14kg

*Ice-Three comes with optional legs. Adds 150mm to Height

MODEL	Description	Price	MODEL	Description	Price
Ice-One	Stainless Steel	£868	Ice-Three	Stainless Steel	£1075

BA Range

Back bar



BA20H



BA10H



BA20S

Features and Benefits

- * Fully Automatic Operation
- * Interior Light
- * Fan Assisted Cooling
- * Double Glazed Door
- * Adjustable Shelving
- * Adjustable Feet
- * BA10H 105 x 330ml Bottle Capacity
- * BA20H 180 x 330ml Bottle Capacity
- * Adjustable Temperature
- * Lock Fitted as Standard

Technical Specifications

Temperature Range	+2/+10°C
Refrigerant	R134A
Type of Defrost	Off Cycle
No. of Shelves	2
Exterior Finish	Black
Interior Finish	Aluminium
Power Required	13 Amp Supply

Dimensions	Height:	Width:	Depth:	Weight:	Capacity:
External					
BA10H	900mm	600mm	520mm	47kg	125ltr. (4.4cu.ft.)
BA20H/S	900mm	900mm	520mm	65.4kg	196ltr. (6.9cu.ft.)
Internal					
BA10H	732mm	508mm	355mm		
BA20H/S	732mm	805mm	345mm		

MODEL	Description	Price	MODEL	Description	Price
BA10H	Black Hinged Door	£429	BA20S	Black Sliding Door	£599
BA20H	Black Hinged Door	£585			

SC1

Back Bar

Features and Benefits

- * Fully Automatic
- * Fan Assisted Cooling
- * Adjustable Shelving
- * Self Closing Door
- * Energy efficient
- Class leading M1 Certification for SC1H - ECA Approved
- See Page 192
- * Ventilation at Front of Cabinet so can be Fully Built in
- * Metal Door Frames with Metal Handles for Extra Durability
- * Wine Shelves Available as an Optional Extra POA
- * Door Not Reversible
- * Adjustable Temperature
- * Switchable Interior Light
- * Lock
- * 104 x 330ml Bottle Capacity
- * Adjustable Feet

Technical Specifications

Temperature Range +2/+7°C
Refrigerant R134A
Type of Defrost Automatic
No. of Shelves 2
Exterior Finish Black, Brown or Black with Silver Doors
Interior Finish Hammered Aluminium
Power Required 13 Amp Supply



SC1H Black

Authorised User No. 00208



Wine Shelves Available POA



Black with Silver Door



Black with Black Door



Brown with Brown Door

Dimensions	Height:	Width:	Depth:	Weight:	Capacity:
External					
SC1H	900mm	600mm	500mm	50kg	125ltr. (4.4cu.ft.)
Internal					
SC1H	760mm	520mm	370mm		

MODEL	Description	Price
SC1H	Hinged Door in Black, Brown or Black with Silver Doors	£449



SC2S Black



SC2H Silver



Authorised User No. 00208

Features and Benefits

- * Fully Automatic
- * Fan Assisted Cooling
- * Adjustable Shelving
- * Self Closing Doors with Stay Open Feature for Easy Loading
- * Energy efficient
Class leading M1 Certification for SC2H - ECA Approved - See Page 192
- * Ventilation at Front of Cabinet so can be Fully Built in
- * Hinged: Durable Powder Coated Aluminium with Metal Handles
- * Sliding: Aluminium Cassette with Plastic Door Frames
- * Wine Shelves Available as an Optional Extra POA
- * Adjustable Temperature
- * Switchable Interior Light
- * Lock
- * 169 x 330ml Bottle Capacity
- * Adjustable Feet and Rollers at rear

Technical Specifications

- Temperature Range** +2/+7°C
Refrigerant R134A
Type of Defrost Automatic
No. of Shelves 2
Exterior Finish Black, Brown or Black with Silver Doors
Interior Finish Hammered Aluminium
Power Required 13 Amp Supply



Wine Shelves Available POA



Black with Silver Door



Black with Black Door



Brown with Brown Doors

Dimensions	Height:	Width:	Depth:	Weight:	Capacity:
External					
SC2	900mm	900mm	500mm	69kg	205ltr. (7.24cu.ft.)
Internal					
SC2	760mm	820mm	370mm		

MODEL	Description	Price	MODEL	Description	Price
SC2H	Hinged Door in Black, Brown or Black with Silver Doors	£620	SC2S	Sliding Door in Black, Brown or Black with Silver Doors	£620

SC3S

Back Bar

Features and Benefits

- * Fully Automatic
- * Fan Assisted Cooling
- * Adjustable Shelving
- * Self Closing Door
- * Energy efficient design
- * Ventilation at Front of Cabinet so can be Fully Built in
- * Aluminium Cassette with Plastic Door Frames
- * Wine Shelves Available as an Optional Extra POA
- * Adjustable Temperature
- * Switchable Interior Light
- * Lock
- * 260 x 330ml Bottle Capacity
- * Adjustable Feet and Rollers at rear

Technical Specifications

- Temperature Range** +2/+7°C
Refrigerant R134A
Type of Defrost Automatic
No. of Shelves 2
Exterior Finish Black,
 Black with Silver
 Doors
Interior Finish Hammered
 Aluminium
Power Required 13 Amp Supply



SC3S Silver



Wine Shelves Available POA



SC3S Black



Dimensions	Height:	Width:	Depth:	Weight:	Capacity:
External					
SC3S	900mm	1335mm	500mm	95kg318ltr. (11.22cu.ft.)
Internal					
SC3S	760mm	1255mm	370mm		

MODEL	Description	Price
SC3S	Sliding Door in Black or Black with Silver Doors	£885

CHILLED DISPLAY

SC Stainless

Stainless Steel Back Bar



SC2H-SS



Authorised User No. 00208



SC3S-SS



SC1H-SS

Features and Benefits

- * Fully Automatic
- * Fan Assisted Cooling
- * Adjustable Shelving
- * Self Closing Door
- * Stainless Steel Exterior and Interior
- * Energy efficient
- Class leading M1 Certification for SC1H and SC2H - ECA Approved - See Page 192
- * Ventilation at Front of Cabinet so can be Fully Built in
- * Wine Shelves Available as an Optional Extra POA
- * Door Not Reversible on SC1H
- * Adjustable Temperature
- * Adjustable Shelving
- * Switchable Interior Light
- * Lock
- * Temperature Display
- * SC1H – 104x330ml bottle capacity
- * SC2 – 169x330ml bottle capacity
- * SC3S – 260x330ml bottle capacity
- * Adjustable feet on SC1H
- * Adjustable feet and Rollers at rear on SC2 and SC3S
- * Hinged models have stainless steel door frames. Sliding models have coated steel surround and plastic door frames

Technical Specifications

Temperature Range	+2/+7°C
Refrigerant	R134A
Type of Defrost	Automatic
No. of Shelves	2 (4 in SC3)
Door Finish	Stainless Steel 304 Grade
Interior Finish	Stainless Steel 304 Grade
Power Required	13 Amp Supply

Dimensions	Height:	Width:	Depth:	Weight:	Capacity:
External					
SC1H-SS	900mm	600mm	500mm	50kg	125ltr. (4.4cu.ft.)
SC2S-SS	900mm	900mm	500mm	69kg	205ltr. (7.24cu.ft.)
SC3S-SS	900mm	1335mm	500mm	95kg	318ltr. (11.22cu.ft.)
Internal					
SC1H-SS	760mm	520mm	370mm		
SC2S-SS	760mm	820mm	370mm		
SC3S-SS	760mm	1255mm	370mm		

MODEL	Description	Price	MODEL	Description	Price
SC1H-SS	Hinged Door Stainless Steel	£647	SC2H-SS	Hinged Door Stainless Steel	£929
SC2S-SS	Sliding Door Stainless Steel	£929	SC3S-SS	Sliding Door Stainless Steel	£1215

CHILLED DISPLAY

LJD Range

Milk / Juice Dispenser

Features and Benefits

- * Paddle System Agitation
- * Fully Automatic Operation
- * Suitable for Juice Containing Fruit Pulp or Milk
- * Easy Dispense
- * Stainless Steel Tap for Easy Cleaning
- * Adjustable Feet
- * Adjustable Temperature

Technical Specifications

Temperature Range . . . +2/+8°C
 Refrigerant R134A
 Type of Defrost Off Cycle
 Exterior Finish Stainless/Grey/
 Polycarbonate
 Bowl
 Power Required 13 Amp Supply



LJD3



LJD2



LJD1



Dimensions	Height:	Width:	Depth:	Weight:	Capacity:
LJD1	635mm	230mm	430mm	19kg	1x12ltr.
LJD2	635mm	430mm	430mm	27kg	2x12ltr.
LJD3	635mm	630mm	430mm	34kg	3x12ltr.

MODEL	Description	Price	MODEL	Description	Price
LJD1	Stainless	£492	LJD3	Stainless	£719
LJD2	Stainless	£599			

CHILLED DISPLAY

VL Range

Juice Dispenser

Features and Benefits

- * Paddle System Agitation
- * Fully Automatic Operation
- * Suitable for Juice Containing Fruit Pulp (Not suitable for milk)
- * Easy Dispense
- * Easy Cleaning
- * Tap is Easy to Dismantle for Cleaning
- * Water Proof Switches
- * Adjustable Feet
- * Adjustable Temperature

Technical Specifications

Temperature Range +3/+10°C
Refrigerant R134A
Type of Defrost Off Cycle
Exterior Finish Stainless
Power Required 13 Amp Supply



Dimensions	Height:	Width:	Depth:	Weight:	Capacity:
External					
VL112	670mm	180mm	460mm	19kg	11.5ltr.
VL223	670mm	335mm	460mm	28kg	23ltr.
VL334	670mm	480mm	460mm	35kg	34.5ltr.

MODEL	Description	Price	MODEL	Description	Price
VL112	Stainless	£688	VL334	Stainless	£1049
VL223	Stainless	£822			

SF Range

Milk / Juice Dispenser

Features and Benefits

- * Paddle System Agitation
- * Fully Automatic Operation
- * Suitable for Milk and Juice Containing Pulp (bits)
- * Easy Cleaning
- * Stainless Steel Tap is Easy to Dismantle for Thorough Cleaning
- * Adjustable Feet
- * Adjustable Temperature

Technical Specifications

Temperature Range +1/+10°C
Refrigerant R134A
Type of Defrost Off Cycle
Exterior Finish Stainless
Power Required 13 Amp Supply



Dimensions	Height:	Width:	Depth:	Weight:	Capacity:
SF112	620mm	190mm	385mm	20kg	1x12ltr.
SF224	620mm	380mm	385mm	34kg	2x12ltr.
SF336	620mm	570mm	385mm	38kg	3x12ltr.

MODEL	Description	Price	MODEL	Description	Price
SF112	Stainless	£718	SF336	Stainless	£1090
SF224	Stainless	£858			

CHILLED DISPLAY

Alfa Range

Sliding Top Bottle Cooler

Features and Benefits

- * Fully Automatic Operation
- * Suitable for use in High Ambient Locations
- * Sliding Top for Easy Access
- * 100% CFC Free
- * Internal Dividers as Standard
- * Bottle Opener
- * High Storage Capacity
- * Removable Lid for ease of loading
- * Adjustable Temperature
- * Dividers can be placed every 50mm to maximise storage area

Technical Specifications

Temperature Range +2/+6°C

Refrigerant R134A

Type of Defrost Off Cycle

Exterior Finish Grey Painted Steel

Interior Finish Aluminium

Power Required 13 Amp Supply



ALFA 1100



ALFA 1400



Dimensions	Height:	Width:	Depth:	Capacity 330ml bottles	Capacity:	Weight:	No. of Lids:	No. of std. Int. Dividers
External								
ALFA 1100	820mm	1100mm	600mm	234	.281ltr.(9.9cu.ft.)	56kg	2	2
ALFA 1400	820mm	1410mm	600mm	324	.380ltr.(13.4cu.ft.)	62kg	3	2
ALFA 1800	820mm	1810mm	600mm	441	.508ltr.(17.9cu.ft.)	73kg	3	3
Internal								
ALFA 1100	738mm	977mm	480mm					
ALFA 1400	738mm	1285mm	480mm					
ALFA 1800	738mm	1685mm	480mm					

MODEL	Description	Price	MODEL	Description	Price
ALFA 1100	White	£604	ALFA 1800	White	£769
ALFA 1400	White	£669			

DEW42

Glass Door Merchandiser



Features and Benefits

- * Fan Assisted Cooling
- * Fully Automatic Operation
- * Double Glazed Door
- * Self Closing Door
- * Interior Light
- * Replaceable Door Gasket
- * Adjustable Shelving
- * Temperature Display
- * Adjustable Feet
- * Interior Light
- * Adjustable Temperature

Technical Specifications

- Temperature Range +1/+4°C
- Refrigerant R134A
- Type of Defrost Off Cycle
- No. of Shelves 5
- Exterior Finish White
- Interior Finish White Plastic
- Power Required 13 Amp Supply



Dimensions	Height:	Width:	Depth:	Weight:	Capacity:
External DEW 42	1860mm.593mm	611mm	84kg.390ltr. (13.7 cu.ft.)
Internal DEW 42	1675mm.514mm	470mm		

MODEL	Description	Price
DEW 42	White	£759

CHILLED DISPLAY

FSC 1380

Glass Door Merchandiser

Features and Benefits

- * Fan Assisted Cooling
- * Lock Fitted as Standard
- * Adjustable Shelving
- * Adjustable Feet
- * Fully Automatic Operation
- * Interior Light
- * Temperature Display
- * Replaceable Door Gasket
- * 100% CFC Free
- * Reversible Door (must be completed before despatch)
- * Adjustable Temperature

Technical Specifications

Temperature Range . . . +1/+12°C
Refrigerant R134A
Type of Defrost Off Cycle
No. of Shelves 5
Exterior Finish White
Interior Finish White Plastic
Power Required 13 Amp Supply



FSC 1380 Canopy



Dimensions	Height:	Width:	Depth:	Weight:	Capacity:
External					
FSC 1380	1980mm	595mm	640mm	105kg	.372ltr. (13.1cu.ft.)
Internal					
FSC 1380	1550mm	470mm	515mm		

MODEL	Description	Price
FSC 1380	White	£689

CHILLED DISPLAY

FS 1380

Glass Door Merchandiser

Features and Benefits

- * Fan Assisted Cooling
- * Lock Fitted as Standard
- * Adjustable Shelving
- * Adjustable Feet
- * Fully Automatic Operation
- * Interior Light
- * Temperature Display
- * Replaceable Door Gasket
- * 100% CFC Free
- * Solid Door Version on Page 113
- * FS1380W Holds between 65-78 75cl wine bottles
- * White Option on wine (POA)
- * Reversible Door (must be completed before despatch)
- * Adjustable Temperature

Technical Specifications

Temperature Range . . . +1/+12°C

Refrigerant R134A

Type of Defrost Off Cycle

No. of Shelves

FS1380 7

FS1380W 6 + Bottom Rack)

Exterior Finish White/Brown

Interior Finish White Plastic

Power Required 13 Amp Supply



FS 1380



FS 1380 Wine



7 Shelves supplied as standard on FS1380

Dimensions	Height:	Width:	Depth:	Weight:	Capacity:
External					
FS 1380	1825mm	595mm	640mm	105kg372ltr. (13.1cu.ft.)
Internal					
FS 1380	1550mm	470mm	515mm		

MODEL	Description	Price	MODEL	Description	Price
FS 1380	White	£599	FS 1380W	Brown	£761

CHILLED DISPLAY

Super 76

Glass Door Merchandiser

Features and Benefits

- * Fully Automatic Operation
- * Fan Assisted Cooling
- * Illuminated Canopy
- * Adjustable Shelving
- * Reversible Door
- * Adjustable Feet on Front
- * Fitted Rollers for Easy Movement
- * Double Glazed Door
- * Door Lock Available (Factory Option)
- * Lock Fitted as Standard on Wine Models
- * Branding Available
- * 98 x 75cl Wine Bottles
- * Takes 500 x 330ml cans
- * Wine shelves and Standard Shelves are not interchangeable
- * Adjustable Temperature
- * Switchable Interior Light
- * Single Vertical Light

Technical Specifications

Temperature Range +2/+10°C

Refrigerant R134A

Type of Defrost Off Cycle

No. of Shelves 5 (wine 8 + Bottom Rack)

Exterior Finish

Super 7 White

Super 7 Wine Brown

Interior Finish White

Power Required 13 Amp Supply



SUPER 76 Wine



SUPER 76



Dimensions	Height:	Width:	Depth:	Weight:	Capacity:
External SUPER 76 with canopy	2000mm	600mm	690mm	94kg	380ltr. (13.6 cu.ft.)
Internal SUPER 76	1540mm	520mm	480mm		

MODEL	Description	Price	MODEL	Description	Price
SUPER 76	White	£890	SUPER 76W	Brown	£1029

Super 800HD

Hinged Glass Door Merchandisers



Lucozade branded version

SUP800HD

Dimensions	Height:	Width:	Depth:	Weight:	Capacity:
External SUPER 800HD					
hinged door	1990mm	880mm	666mm	130kg	765ltr. (27cu.ft.)
Internal SUPER 800HD	1590mm	800mm	602mm		

Features and Benefits

- * Fully Automatic Operation
- * Switchable Interior Light
- * Double Glazed Doors
- * Fan Assisted Cooling
- * Illuminated Canopy
- * Adjustable Shelving
- * Fitted Rollers for Easy Movement
- * Branding Available
- * Lock Option Available (Factory Fitted)
- * 937 x 330ml Cans Capacity
- * 430 x 500ml PET Bottles

Technical Specifications

Temperature Range	+2/+6°C
Refrigerant	R134A
Type of Defrost	Off Cycle
No. of Shelves	
SUPER 88HD	5
Exterior Finish	White
Interior Finish	White
Power Required	13 Amp Supply

MODEL	Description	Price
SUPER 800HD	White	£1566

Super 800SD

Sliding Glass Door Merchandisers



SUP800SD

Dimensions	Height:	Width:	Depth:	Weight:	Capacity:
External SUPER 800SD					
sliding door	1990mm	889mm	713mm	130kg	791ltr. (27.9cu.ft.)
Internal SUPER 800SD	1590mm	800mm	602mm		

Features and Benefits

- * Fully Automatic Operation
- * Switchable Interior Light
- * Double Glazed Doors
- * Fan Assisted Cooling
- * Self Closing Door
- * Illuminated Canopy
- * Adjustable Shelving
- * Fitted Rollers for Easy Movement
- * Branding Available
- * Lock Option Available (Factory Fitted)
- * 937 x 330ml Cans Capacity
- * 430 x 500ml PET Bottles

Technical Specifications

Temperature Range	+2/+6°C
Refrigerant	R134A
Type of Defrost	Off Cycle
No. of Shelves	5
Exterior Finish	White
Interior Finish	White
Power Required	13 Amp Supply

MODEL	Description	Price
SUPER 800SD	White	£1629



EIS42/104

Glass Door Merchandiser

Features and Benefits

- * Fan Assisted Cooling
- * Fully Automatic Operation
- * Adjustable Shelving
- * Switchable Interior Light
- * Illuminated Canopy
- * Adjustable Temperature
- * Temperature Display
- * Freezer Option Page 100
- * Adjustable Feet
- * Vertical Lighting

Technical Specifications

Temperature Range . . . +2/+6°C

Refrigerant R134A

Type of Defrost Off Cycle

No. of Shelves 4

Exterior Finish

EIS42: White, Grey

EIS104: White, Black

Interior Finish White

Power Required 13 Amp Supply

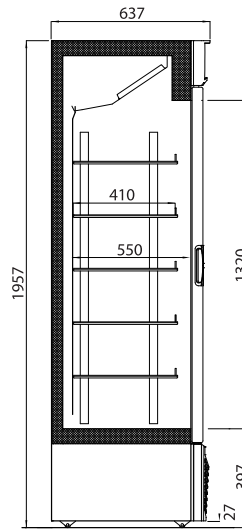

EIS42



EIS104

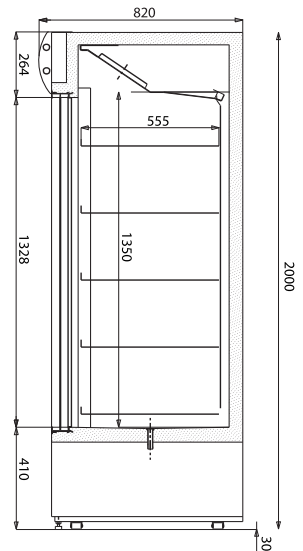

Dimensions	Height:	Width:	Depth:	Weight:	Capacity:
External					
EIS42	1957mm	670mm	610mm	98kg	404ltr. (14.2 cu.ft.)
EIS104	2000mm	1110mm	820mm	205kg	1040ltr. (36.7 cu.ft.)
Internal					
EIS42	1300mm	550mm	410mm		
EIS104	1328mm	990mm	555mm		

MODEL	Description	Price	MODEL	Description	Price
EIS42	White	£1180	EIS104	White	£2201

EIS214

Glass Door Merchandiser

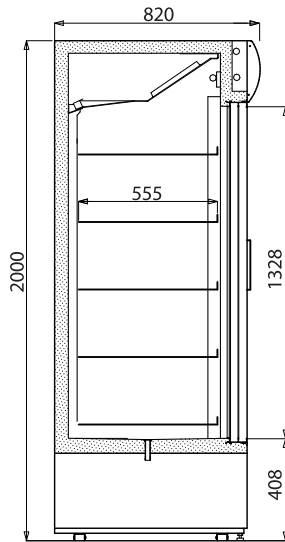

Features and Benefits

- * Fan Assisted Cooling
- * Fully Automatic Operation
- * Adjustable Shelving
- * Adjustable Feet
- * Switchable Interior Light
- * Temperature Display
- * Triple Sliding Self Closing Doors
- * Adjustable Temperature

Technical Specifications

Temperature Range	+2/+6°C
Refrigerant	R134A
Type of Defrost	Off cycle
No. of Shelves	5 per door
Exterior Finish	White, Black
Interior Finish	White
Power Required	13 Amp Supply



EIS214

Dimensions	Height:	Width:	Depth:	Weight:	Capacity:
External					
EIS214	2000mm	1970mm	820mm	390kg	2040ltr. (72 cu.ft.)
Internal					
EIS214	1328mm	1850mm	555mm		

MODEL	Description	Price
EIS214	White	£3498

Expo Range

Glass Door Merchandiser

Features and Benefits

- * Fully Automatic Operation
- * Fan Assisted Cooling
- * Illuminated Canopy
- * Freezer Option Page 99
- * Adjustable Shelving
- * Double Glazed Door
- * Replaceable Door Gasket
- * Temperature Display
- * Adjustable Temperature
- * Switchable Interior Light
- * Twin Vertical Lighting

Technical Specifications

Temperature Range . . . +1/+15°C

Refrigerant R134A

Type of Defrost Off Cycle

No. of Shelves

EXPO500 5

EXPO1100 10 (5+5)

Exterior Finish White

Interior Finish White

Power Required 13 Amp Supply



EXPO 500PT



EXPO 1100PT



Dimensions	Height:	Width:	Depth:	Weight:	Capacity:
External					
EXPO 500PT	1980mm	670mm	642mm	119kg472ltr. (16.7cu.ft.)
EXPO 1100PT	1980mm	1342mm	752mm	206kg	1.047ltr. (36.9cu.ft.)
Internal					
EXPO 500PT	1440mm	598mm	513mm		
EXPO 1100PT	1525mm	1221mm	571mm		

MODEL	Description	Price	MODEL	Description	Price
EXPO 500PT	White	£1315	EXPO 1100PT	White	£2831

CHILLED DISPLAY



FS 2700

Dimensions	Height:	Width:	Depth:	Weight:	Capacity:
External					
FS 2700	2035mm	1000mm	630mm	235kg	720ltr. (25.4cu.ft.)
Internal					
FS 2700	1440mm	910mm	500mm		

MODEL	Description	Price
FS 2700	White	£1199

FS 2700

Glass Door Merchandiser

Features and Benefits

- * Fan Assisted Cooling
- * Interior Light
- * Adjustable Shelving
- * Adjustable Feet
- * 5 Shelves as Standard Per Side
- * Fully Automatic Operation
- * Door Loading Locks
- * Door Gasket Not Replaceable - New Door Needed
- * Temperature Display
- * Lock Available P.O.A
- * Maximum 40°C Ambient
- * Adjustable Temperature

Technical Specifications

Temperature Range	+3/+7°C
Refrigerant	R134A
Type of Defrost	Off Cycle
No. of Shelves	5 per side
Exterior Finish	White
Interior Finish	White Plastic
Power Required	13 Amp Supply

CAR1300G

Glass Door Merchandiser



CAR1300SG

CAR1300WG

Dimensions	Height:	Width:	Depth:	Weight:	Capacity:
External					
CAR1300	2000mm	1420mm	800mm	255kg	1300ltr. (45.9cu.ft.)
Internal					
CAR1300	1480mm	1300mm	680mm		

MODEL	Description	Price	MODEL	Description	Price
CAR1300WG	White Glass Door	£2437	CAR1300SG	Stainless Glass Door	£2878



Features and Benefits

- * Fully Automatic Fan Assisted
- * Suitable for High Ambient (42°C)
- * Adjustable Shelving
- * Switchable Interior Light
- * Stainless Steel Interior
- * White or Stainless Exterior Options
- * Temperature Display
- * Top Mounted Refrigeration Unit
- * Lock
- * Freezer Option see Page 101
- * Electronic Controller

Technical Specifications

Temperature Range	0/+10°C
Refrigerant	R134A
Type of Defrost	Electric
No. of Shelves	5 per side
Exterior Finish	White or Stainless Steel
Interior Finish	Stainless Steel
Power Required	13 Amp Supply

CHILLED DISPLAY

HD Range

Hinged Glass Door Merchandiser

Features and Benefits

- * Fan Assisted Cooling
- * Interior Lights
- * Automatic Operation
- * Adjustable Cantilever Shelving
- * Illuminated Canopy
- * Adjustable Feet
- * Temperature Display
- * Double Glazed Doors with Energy Saving Low E Glass
- * Optional Lockable Door (Factory fitted only)
- * Suitable for use in high ambient (43°C)
- * Adjustable Temperature

Technical Specifications

Temperature Range . . . +1/+10°C

Refrigerant R134A

Type of Defrost Off Cycle

No. of Shelves

HD690 4

HD890/HD1140/

HD1360 4 + 4

Exterior Finish White

Interior Finish White

Power Required 13 Amp Supply



Pictures show branded versions
Stainless version available P.O.A.



HD 690



HD 890



HD 1140



HD 1360



Dimensions	Height:	Width:	Depth:	Weight:	Capacity:
External					
HD 690	2020mm	690mm	635mm	117kg	.525ltr. (18.5cu.ft.)
HD 890	2020mm	890mm	635mm	152kg	.700ltr. (24.7cu.ft.)
HD 1140	2020mm	1140mm	635mm	180kg	.920ltr. (32.5cu.ft.)
HD 1360	2020mm	1360mm	635mm	208kg	1.110ltr. (39.2cu.ft.)
Internal					
HD 690	1380mm	600mm	550mm		
HD 890	1380mm	800mm	550mm		
HD 1140	1380mm	1050mm	550mm		
HD 1360	1380mm	1270mm	550mm		



Authorised User No. 00208

HD1140 & HD1360 are
ECA approved.
See Page 192
for how to claim.

MODEL	Description	Price	MODEL	Description	Price
HD 690	White	£1026	HD 1140	White	£1430
HD 890	White	£1231	HD 1360	White	£1695

SD Range

Sliding Glass Door Merchandisers



Picture shows Branded option



SD 890



SD 1140



SD 1360

Features and Benefits

- * Fan Assisted Cooling
- * Interior Light
- * Fully Automatic Operation
- * Adjustable Shelving
- * Illuminated Canopy
- * Adjustable Feet
- * Temperature Display
- * Double Glazed Doors with Energy Saving Low E Glass
- * Self Closing Doors
- * Suitable for use in high ambient (43°C)
- * Optional Door Lock (POA)
- * Adjustable Temperature

Technical Specifications

- Temperature Range . . . +1/+10°C
- Refrigerant R134A
- Type of Defrost Off Cycle
- No. of Shelves 4 + 4
- Exterior Finish White
- Interior Finish White
- Power Required 13 Amp Supply

SD1140 & SD1360 are ECA approved. See Page 192 for how to claim.



Authorised User No. 00208

Dimensions	Height:	Width:	Depth:	Weight:	Capacity:
External					
SD 890	2020mm	890mm	635mm	152kg	675ltr. (23.8cu.ft.)
SD 1140	2020mm	1140mm	635mm	180kg	890ltr. (31.4cu.ft.)
SD 1360	2020mm	1360mm	635mm	208kg	1075ltr. (38.0cu.ft.)
Internal					
SD 890	1380mm	800mm	515mm		
SD 1140	1380mm	1050mm	515mm		
SD 1360	1380mm	1270mm	515mm		

MODEL	Description	Price	MODEL	Description	Price
SD 890	White	£1124	SD 1360	White	£1562
SD 1140	White	£1327			

CHILLED DISPLAY

Hera Range

3/4 Vision

Features and Benefits

- * Fully Automatic Operation
- * Replaceable Door Gaskets
- * Hinged Front Glass for easy Loading/Cleaning
- * Interior Light
- * 1 Shelf as Standard
- * Digital Temperature Display
- * Load and Serve from Rear Doors
- * Adjustable Temperature

Technical Specifications

Temperature Range. -2/+6°C
Refrigerant R134A
Type of Defrost Electric
Exterior Finish Stainless/ABS
Interior Finish Stainless
Power Required 13 Amp Supply



Hera 150 S



Hera 100 M



Dimensions	Height:	Width:	Depth:	Weight:	Capacity:	Storage Doors
External						
Hera 100	1075mm	1085mm	810mm	120kg	.340ltr. (12cu.ft.)	1
Hera 150	1075mm	1540mm	810mm	162kg	.501ltr. (17.6cu.ft.)	2
Hera 200	1075mm	2040mm	810mm	189kg	.673ltr. (23.7cu.ft.)	3
Internal						
Hera 100S	660mm	.955mm	600mm			
Hera 150S	660mm	.1410mm	600mm			
Hera 200S	660mm	.1910mm	600mm			

NB. M Version is 10mm narrower than S Version externally.

MODEL	Description	Price	MODEL	Description	Price
HERA 100 S	Red	£1699	HERA 100 M	Wood	ORDER £1833
HERA 150 S	Red	£1992	HERA 150 M	Wood	ORDER £2130
HERA 200 S	Red	£2379	HERA 200 M	Wood	ORDER £2495

Diana

Counter Top Display

Features and Benefits

- * Fully Automatic Operation
- * Sliding Glass Doors
- * Digital Temperature Display
- * Switchable Interior Light
- * 2 Shelves as Standard
- * Stainless Steel Construction
- * Adjustable Temperature

Technical Specifications

Temperature Range. +3/+10°C
Refrigerant R134A
Type of Defrost Automatic
Exterior Finish ABS/Aluminium
Interior Finish Stainless
Power Required 13 Amp Supply



Diana 150



Dimensions	Height:	Width:	Depth:	Weight:	Capacity:
Diana 100	1170mm	1020mm	605mm	94kg	.225ltr. (7.9cu.ft.)
Diana 130	1170mm	1320mm	605mm	109kg	.298ltr. (10.5cu.ft.)
Diana 150	1170mm	1470mm	605mm	118kg	.348ltr. (12.3cu.ft.)

MODEL	Description	Price	MODEL	Description	Price
DIANA 100 S	Red	ORDER £1378	DIANA 150 S	Red	ORDER £1773
DIANA 130 S	Red	£1629			

CHILLED DISPLAY



Vatel Range

Display Cabinet

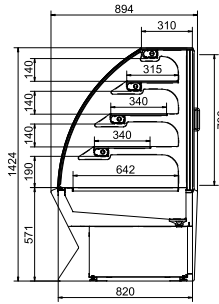

Features and Benefits

- * Fan Assisted Cooling
- * Fully Automatic Operation
- * Adjustable Temperature
- * Double Glazed Glass
- * Sliding Doors To Rear
- * Individually Illuminated Glass Shelves
- * Anti Mist Glass
- * Switchable Lights
- * Digital Temperature Display
- * Digital Controller

Technical Specifications

Temperature Range 0/+10°C
 Refrigerant R134A
 Type of Defrost Timed Off Cycle
 No. of Shelves Base + 3 (Fixed)
 Exterior Finish White/Brown
 Interior Finish Stainless/Glass
 Power Required 13 Amp Supply

VATEL 140

Dimensions	Height:	Width:	Depth:	Weight:	Display Area:
Vatel 90	1424mm	960mm	894mm	159kg	1.4m ³
Vatel 110	1424mm	1160mm	894mm	194kg	1.73m ³
Vatel 140	1424mm	1460mm	894mm	248kg	2.22m ³

MODEL	Description	Price	MODEL	Description	Price
Vatel 90	White	£2597	Vatel 140	White	£3219
Vatel 110	White	£2932			



Brio 185 Cold

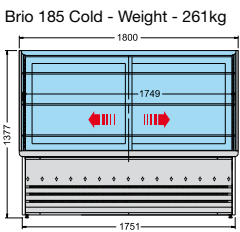

Brio 185 Cold - Weight - 261kg



Brio 135 Cold

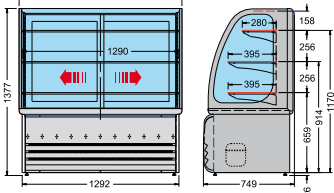

Brio 135 Cold - Weight - 231kg



Brio 135 Hot - Weight - 205kg

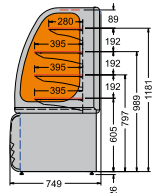

Brio Range

Chilled/Heated Display Cabinet

Features and Benefits

- * Double Glazed Curved Glass
- * Fully Automatic Operation
- * Switchable Interior Light
- * Rear Sliding Doors
- * 3 Shelves as Standard (4 on hot)
- * Electronically Controlled
- * Castors Fitted (Lockable to Rear Only)
- * Auto Defrost – on cold version
- * Fan Assisted Cooling on Cold Version
- * Anti Mist Glass (fan assist)
- * Adjustable Temperature

Technical Specifications

Temperature Range
 Brio 135/185 Cold 0/+10°C
 Brio 135 Hot +60/+80°C
 Refrigerant R404A
 Type of Defrost Timed Off Cycle
 Exterior Finish White/Grey
 Interior Finish Glass S/Steel
 Power Required 13 Amp Supply

Please check door width/site access before ordering.

Chocolate Version Available P.O.A.

MODEL	Description	Price	MODEL	Description	Price
BRIO 135 COLD	White	£3789	BRIO 185 COLD	White	£4572
BRIO 135 HOT	White	£4789	BRIO 135 Ambient White		£3299



CHILLED DISPLAY



Verona

Fish/meat Serveover

Features and Benefits

- * Fully Automatic Operation
- * Interior Light
- * Automatic Defrost
- * Static Cooling
- * Sliding Rear Doors as Standard
- * Anti Acid Coated Evaporator
- * Electric Control Panel
- * Suitable for Fresh Meat or fresh fish
- * 304 Grade Stainless Steel
- * Automatic Temperature

Technical Specifications

Temperature Range . . . -2/+6°C
 Refrigerant R404A
 Type of Defrost Off Cycle
 No. of Shelves 2
 Exterior Finish Stainless Steel
 Interior Finish Stainless Steel
 Power Required 13 Amp Supply



Verona 120 Mobile



Verona 120 Counter Top

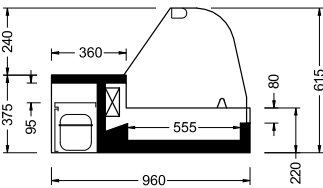

Verona 120

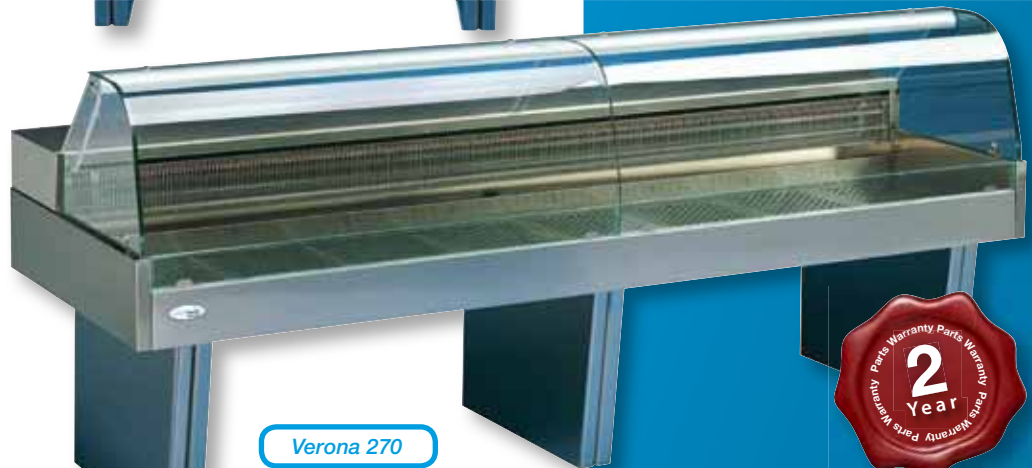
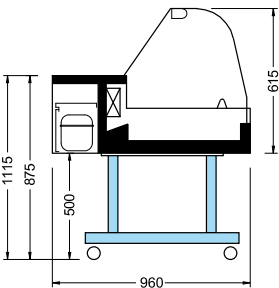

Verona 270

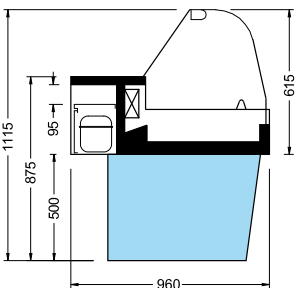

	Weight	Trolley adds	Legs add	Length
110	.115kg	.12kg	20kg	1061mm
120	.125kg	.12kg	20kg	1394mm
200	.165kg	.13kg	22kg	2038mm
270	.245kg	.15kg	26kg	2682mm

Please check door width/site access before ordering.

MODEL	Description	Price	MODEL	Description	Price
VERONA 110			VERONA 200		
Counter Top	Stainless Steel	£2348	Counter Top	Stainless Steel	£3278
Trolley	Black Steel	£117	Trolley	Black Steel	£161
Legs	Stainless Steel	£218	Legs	Stainless Steel	£309
VERONA 120			VERONA 270		
Counter Top	Stainless Steel	£2579	Counter Top	Stainless Steel	£3805
Trolley	Black Steel	£117	Trolley	Black Steel	£168
Legs	Stainless Steel	£218	Legs	Stainless Steel	£309

CHILLED DISPLAY

Celebrity

Mobile Display Counter



Features and Benefits

- * Fully Automatic Operation
- * Stainless Steel Interior
- * Temperature Display
- * Flat or Curved Glass
- * Trolley included but can be Counter Mounted
- * Stainless Steel Deck and Rear Shelf
- * Adjustable Temperature
- * Ambient Glass Shelf
- * Low Glass Fish/Meat Option on Page 30

Technical Specifications

Temperature Range . . . +2/+6°C
Refrigerant R134A
Type of Defrost Off Cycle
Exterior Finish White
Interior Finish Stainless
Power Required 13 Amp Supply



Celebrity 150 Flat Glass



Celebrity 150 Curved Glass



Digital Controller



Rear of unit

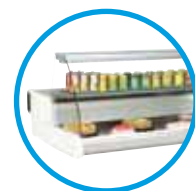

Unit can be used without trolley



Low Glass version available POA



Dimensions	Height:	Width:	Depth:	Weight:
Celebrity 100F	1230mm	1010mm	1068mm	116kg
Celebrity 150F	1230mm	1510mm	1068mm	154kg
Celebrity 200F	1230mm	2010mm	1068mm	188kg
Celebrity 100C	1250mm	1010mm	1068mm	116kg
Celebrity 150C	1250mm	1510mm	1068mm	154kg
Celebrity 200C	1250mm	2010mm	1068mm	188kg

MODEL	Description	Price	MODEL	Description	Price
CELEBRITY			CELEBRITY		
100 Flat	White/Grey	£1218	100 Curved	White/Grey	£1330
150 Flat	White/Grey	£1458	150 Curved	White/Grey	£1569
200 Flat	White/Grey	£1658	200 Curved	White/Grey	£1889

CHILLED DISPLAY



Prima

Slimline Serve Over Counter

Features and Benefits

- * Fully Automatic Cooling
- * Stainless Steel Interior, Rear Shelf and Deck
- * Electronically Controlled
- * Switchable Interior Light
- * Digital Temperature Display and Controller
- * Refrigerated Understorage
- * 13 amp Socket at Rear for Scales/Till etc
- * Ambient Shelf
- * Adjustable Temperature
- * Adjustable feet
- * Only 822mm deep
- * Suitable for use in ambient of 25°C and 60% RH
- * Perspex Rear Sliding Doors
- * Hinged Doors to Understorage

Technical Specifications

Temperature Range +2/+5°C
 Refrigerant R134A
 Type of Defrost Off Cycle
 Exterior Finish White/Grey
 Interior Finish Stainless Steel
 Power Required 13 Amp Supply

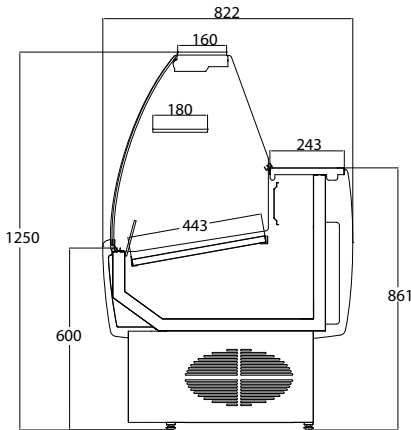

Only
822mm
deep



PRIMA 150

Dimensions	Height:	Width:	Depth:
PRIMA 100	1250mm	1000mm	822mm
PRIMA 130	1250mm	1300mm	822mm
PRIMA 150	1250mm	1500mm	822mm
PRIMA 170	1250mm	1700mm	822mm
PRIMA 200	1250mm	2000mm	822mm

MODEL	Description	Price	MODEL	Description	Price
PRIMA 100	Curved Glass	£1371	PRIMA 170	Curved Glass	£1845
PRIMA 130	Curved Glass	£1535	PRIMA 200	Curved Glass	£2043
PRIMA 150	Curved Glass	£1668			

CHILLED DISPLAY

Abela

Slimline Serve Over Counter



Features and Benefits

- * Fully Automatic Operation
- * Stainless Steel Interior, rear shelf and deck
- * Electronically Controlled
- * Switchable Interior Light
- * Digital Temperature Display
- * Refrigerated Under Storage as Standard
- * 13 amp Socket for Slicer/Scales, etc.
- * Only 825mm Deep
- * Ambient Shelf on Red Version
- * Adjustable Temperature
- * Must be used with Deck Grids Supplied for Correct Operation
- * Suitable for use in ambient of 25°C and 60% RH
- * Perspex Rear Sliding Doors
- * Hinged Doors to Understorage

Technical Specifications

Temperature Range +2/+5°C
 Refrigerant R134A
 Type of Defrost Off Cycle
 Exterior Finish White
 (coloured trim)
 Interior Finish Stainless Steel
 Power Required 13 Amp Supply

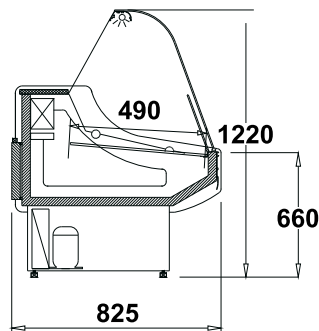

Only 825mm deep



ABELA 150

Dimensions	Height:	Width:	Depth:	Weight:
ABELA 100	1220mm	1070mm	825mm	110kg
ABELA 130	1220mm	1310mm	825mm	120kg
ABELA 150	1220mm	1510mm	825mm	140kg
ABELA 170	1220mm	1710mm	825mm	150kg
ABELA 205	1220mm	2050mm	825mm	175kg

IMPORTANT. Please check door width/site access before ordering. Additional charges apply for unpack and installation. Please refer to sales office for further information.

MODEL	Description	Price	MODEL	Description	Price
ABELA 100 Red	White/Red + Ambient Shelf	£1449	ABELA 170 Red	White/Red + Ambient Shelf	£1952
ABELA 130 Red	White/Red + Ambient Shelf	£1627	ABELA 205 Red	White/Red + Ambient Shelf	£2129
ABELA 150 Red	White/Red + Ambient Shelf	£1755			

CHILLED DISPLAY



Porto

Serve Over Counter

Features and Benefits

- * Fully Automatic Operation
- * Electronically Controlled
- * Switchable Interior Light
- * Digital Temperature Display
- * Refrigerated Under Storage as Standard
- * Stainless Steel Interior - Rear Shelf & Interior Deck
- * 13 amp Socket for Slicer/Scales, etc.
- * Adjustable Temperature
- * Must be used with Deck Grids Supplied for Correct Operation
- * Suitable for use in ambient of 25°C and 60% RH

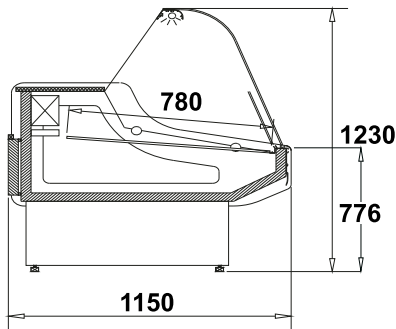

Technical Specifications

- Temperature Range . . . +2/+5°C
- Refrigerant R134A
- Type of Defrost Off Cycle
- Exterior Finish White (coloured trim)
- Interior Finish Stainless Steel
- Power Required 13 Amp Supply



PORTO 140

Dimensions	Height:	Width:	Depth:	Weight:
PORTO 140	1230mm	1380mm	1150mm	160kg
PORTO 170	1230mm	1680mm	1150mm	185kg
PORTO 210	1230mm	2010mm	1150mm	210kg

IMPORTANT. Please check door width/site access before ordering. Additional charges apply for unpack and installation. Please refer to sales office for further information.

MODEL	Description	Price	MODEL	Description	Price
PORTO 140	White	£1997	PORTO 210	White	£2598
PORTO 170	White	£2189			

CHILLED DISPLAY

Geres Range

Serve-over Counter/Flat Glass



Features and Benefits

- * Fully Automatic Operation
- * Stainless Steel Interior, rear shelf and deck
- * Electronically Controlled
- * Switchable Interior Light
- * Digital Temperature Display
- * Separately Controlled Deck and Storage Compartments
- * Intermediate Ambient Shelf
- * Multiplexable Runs Available (Factory Order Only)
- * Refrigerated Under Storage as Standard
- * 13 amp Socket for Slicer/Scales, etc.
- * Downlighter to front as standard
- * Adjustable Temperature
- * Suitable for use in ambient of 25°C and 60% RH

Technical Specifications

Temperature Range +2/+5°C
Refrigerant R134A
Type of Defrost Off Cycle
Exterior Finish White
 (coloured trim)
Interior Finish Stainless Steel
Power Required 13 Amp Supply



Geres 1.5m Flat Glass Grey

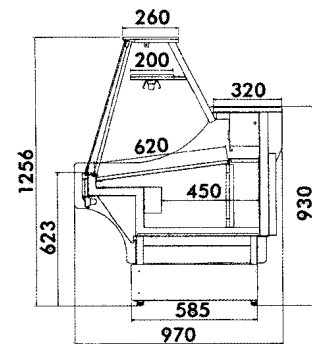

Multiplexed Run including Flat Glass 90° External Corner option



Red Trim Option



Blue Trim Option



Rear doors to under storage

IMPORTANT. Multiplexed runs of Geres are factory order only. Reduction for end walls and multiplexing kit are included in the price of the corner unit. Please check door width/site access before ordering. Additional charges apply for unpack and installation. Please refer to sales office for further information.

MODEL	Description	Price	Trim Colour Options:-
GERES 10F	White	£1517	Grey
GERES 15F	White	£1835	Blue
GERES 20F	White	£2209	Red
GERES 25F	White	£2551	Ceramic tiles still available on request
GERES 30F	White	£3215	
90° External Corner	White	£1899	



Geres Range

Serve-over Counter/Curved Glass



Geres 2m Curved Glass Red

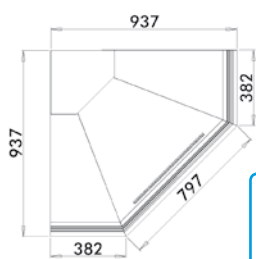
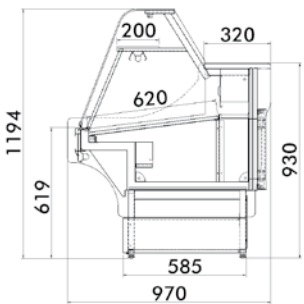

Blue Trim Option



Multiplexed Run with 90° corner – Grey Trim



Dimensions	Height Flat:	Height Curved:	Width:	Depth:	Display Display Area:	Storage Doors:	Weight:
GERES 1m	1256mm	1194mm	1000mm	970mm	1.0m / 0.549m ²	1	190kg
GERES 1.5m	1256mm	1194mm	1500mm	970mm	1.5m / 0.854m ²	1	246kg
GERES 2m	1256mm	1194mm	2000mm	970mm	2.0m / 1.159m ²	2	305kg
GERES 2.5m	1256mm	1194mm	2500mm	970mm	2.5m / 1.464m ²	3	360kg
GERES 3m	1256mm	1194mm	2900mm	970mm	3.0m / 1.700m ²	4	448kg
90°EXT Corner	1256mm	1194mm	937mm	937mm	0.57m ²	N/A	135kg

IMPORTANT. Multiplexed runs of Geres are factory order only. Reduction for end walls and multiplexing kit are included in the price of the corner unit. Please check door width/site access before ordering. Additional charges apply for unpack and installation. Please refer to sales office for further information.

MODEL	Description	Price	Trim Colour Options:-
GERES 10C	White	£1679	Grey
GERES 15C	White	£1940	Blue
GERES 20C	White	£2648	Red
GERES 25C	White	£3016	Ceramic tiles still available on request
GERES 30C	White	£3522	
90° External Corner	White	£2261	

CHILLED DISPLAY

Tamega Range

Serve-over Counter/Flat Glass



Features and Benefits

- * Fully Automatic Operation
- * Electronically Controlled
- * Easy Clean Interior
- * Switchable Interior Light
- * Digital Temperature Display
- * Refrigerated Storage as Standard
- * Intermediate Ambient Shelf as Standard
- * Stainless Steel Interior - Rear Shelf & Interior Deck
- * Multiplexable Runs Available (Factory Order Only)
- * Downlighter to Front as Standard
- * Choice of Colours
- * Separately Controlled Deck and Storage Compartments
- * 13 amp Socket for Slicer/Scales, etc.
- * Adjustable Temperature
- * Suitable for use in ambient of 25°C and 60% RH

Technical Specifications

Temperature Range . . . +2/+5°C
Refrigerant R134A
Type of Defrost Off Cycle
Exterior Finish White
 (coloured trim)
Interior Finish Stainless Steel
Power Required 13 Amp Supply

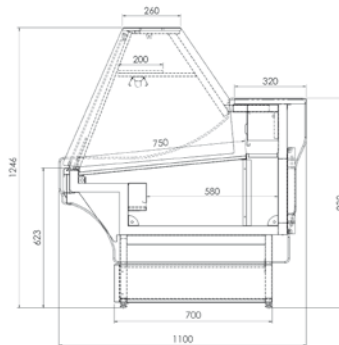

Red Trim Option



Grey Trim Option



Tamega 2m Flat Glass Blue



Dimensions	Height Flat:	Height Curved:	Width:	Depth:	Display Display Area:	Storage Doors:	Weight:
TAMEGA 1m	1246mm	1256mm	1000mm	1100mm	1.0m / 0.707m ²	1201kg
TAMEGA 1.5m	1246mm	1256mm	1500mm	1100mm	1.5m / 1.099m ²	1260kg
TAMEGA 2m	1246mm	1256mm	2000mm	1100mm	2.0m / 1.492m ²	2325kg
TAMEGA 2.5m	1246mm	1256mm	2500mm	1100mm	2.5m / 1.884m ²	3385kg
TAMEGA 3m	1246mm	1256mm	2900mm	1100mm	3.0m / 2.198m ²	4488kg
90°EXT Corner	1246mm	1256mm	1067mm	1067mm	0.78m ²N/A142kg

IMPORTANT. Multiplexed runs of Tamega are factory order only. Reduction for end walls and multiplexing kit are included in the price of the corner unit. Please check door width/site access before ordering. Additional charges apply for unpack and installation. Please refer to sales office for further information.

MODEL	Description	Price	Trim Colour Options:-
TAMEGA 10F	White	£1648	Grey
TAMEGA 15F	White	£2065	Blue
TAMEGA 20F	White	£2590	Red
TAMEGA 25F	White	£2921	Ceramic tiles still available on request
TAMEGA 30F	White	£3408	
90° External Corner	White	£2177	

CHILLED DISPLAY



Tamega Range

Serve-over Counter/Curved Glass



Tamega 2m Curved Glass Grey

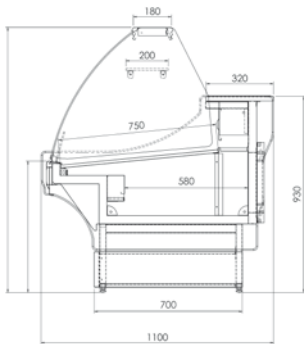

Tamega Corner Multiplex with tiles Ambient Section/Scale Counter P.O.A. Tile Strips still available to order P.O.A.

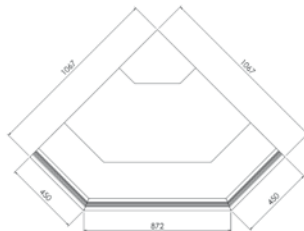

Rear doors to under storage



Control Panel

IMPORTANT. Multiplexed runs of Tamega are factory order only. Reduction for end walls and multiplexing kit are included in the price of the corner unit. Please check door width/site access before ordering. Additional charges apply for unpack and installation. Please refer to sales office for further information.

MODEL	Description	Price	Trim Colour Options:-
TAMEGA 10C	White	£1759	Grey
TAMEGA 15C	White	£2173	Blue
TAMEGA 20C	White	£2684	Red
TAMEGA 25C	White	£3259	Ceramic tiles still available on request
TAMEGA 30C	White	£3807	
90° External Corner	White	£2518	

Tamega Meat

Serve-over Counter for Fresh Meat



Features and Benefits

- * Fan Assisted Cooling
- * Switchable Interior Light
- * Fully Automatic Operation
- * Electronically Controlled
- * Digital Temperature Display
- * Downlighter to Front as Standard
- * Stainless Steel Interior - rear shelf and deck
- * Flat or Curved Glass
- * Multiplexable Factory Option
- * N.B No Understorage
- * Flat Deck
- * Intermediate Ambient Shelf as Standard
- * Adjustable Temperature
- * Suitable for use in ambient of 25°C and 60% RH

Technical Specifications

- Temperature Range** -2/+2°C
Refrigerant R134A
Type of Defrost Hot Gas
Exterior Finish White (coloured trim)
Interior Finish Stainless Steel
Power Required 13 Amp Supply

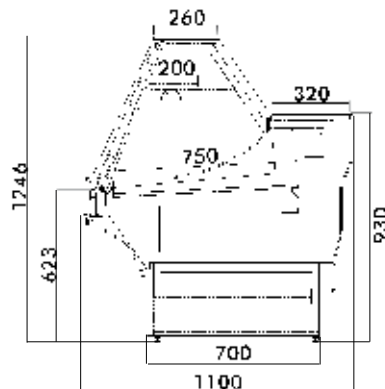

Tamega 2m Flat Glass Blue

Dimensions	Height Flat:	Height Curved:	Width:	Depth:	Display Display Area:	Weight:
TAMEGA MEAT 15C/F	1246mm	1256mm	1500mm	1100mm	1.5m / 1.099m ²	260kg
TAMEGA MEAT 20C/F	1246mm	1256mm	2000mm	1100mm	2.0m / 1.492m ²	325kg
TAMEGA MEAT 25C/F	1246mm	1256mm	2500mm	1100mm	2.5m / 1.884m ²	385kg
TAMEGA MEAT 30C/F	1246mm	1256mm	3000mm	1100mm	3.0m / 2.198m ²	488kg

IMPORTANT. Multiplexed options available, can be multiplexed to all Tamega models with corner unit. Full height divider available for temperature separation. Please check door width/site access before ordering. Additional charges apply for unpack and installation. Please refer to sales office for further information.

MODEL	Description	Price	Trim Colour Options:-
TAMEGA MEAT 15F	White	£2342	Grey
TAMEGA MEAT 20F	White	ORDER £2799	Blue
TAMEGA MEAT 25F	White	ORDER £3357	Red
TAMEGA MEAT 30F	White	ORDER £3950	Ceramic tiles still available on request

CHILLED DISPLAY

Celebrity Fish

Mobile Fish/Meat Display Counter



Features and Benefits

- * Fully Automatic
- * Low Height Glass
- * Suitable for Fish or Meat
- * Adjustable Temperature
- * Digital Temperature Display and Controller
- * Drain Fitted for Easy Cleaning
- * Crushed Ice Recommended for Displaying Fish
- * Unit Supplied on Trolley
- * Lockable Castors Fitted on Trolley
- * Suitable for Up to 25°C Ambient
- * Unit Should not be placed in Direct Sunlight
- * Deli Option on Page 32

Technical Specifications

Temperature Range . . . -1/+3°C
Refrigerant R134A
Type of Defrost Automatic Off Cycle
Exterior Finish White
Interior Finish Stainless Steel
Power Required 13 Amp Supply



Dimensions	Height:	Width:	Depth:
Celebrity Fish 100 . . .	1160mm	1120mm	1130mm
Celebrity Fish 150 . . .	1160mm	1620mm	1130mm
Celebrity Fish 200 . . .	1160mm	2120mm	1130mm

If you want to Counter Mount – Contact Sales before ordering

MODEL	Description	Price	MODEL	Description	Price
CEL100 Fish	White	£1231	CEL200 Fish	White	£1804
CEL150 Fish	White	£1496			

Pacific 680/1000

Counter Top Display Chiller

Features and Benefits

- * Self Serve Front Sliding Door
- * Rear Sliding Doors for Loading
- * Digital Temperature Display
- * Suitable for Fresh Fish or Fresh Meat (Fish must be used in conjunction with crushed ice)
- * Tempered Glass
- * Switchable Interior Light
- * Gastronorm Pans not Supplied – See Page 184
- * Adjustable Temperature
- * Hot Option - See Page 82

Technical Specifications

Temperature Range . . . 0/+7°C
Refrigerant R134A
Type of Defrost Manual
Exterior Finish Stainless/Glass
Interior Finish Stainless
Power Required 13 Amp Supply



Pacific 1000



Pacific 680

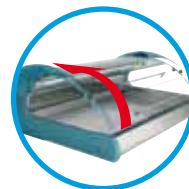
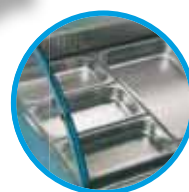

Dimensions	Height:	Width:	Depth:	Capacity:
PACIFIC 680	400mm	680mm	882mm	2X1/1 Gastro Pans
PACIFIC 1000	400mm	1000mm	882mm	3X1/1 Gastro Pans

MODEL	Description	Price	MODEL	Description	Price
PACIFIC 680	Stainless / Glass	£1687	PACIFIC 1000	Stainless / Glass	£2087

CHILLED DISPLAY



Tamega Meat

Serve-over Counter for Fresh Meat

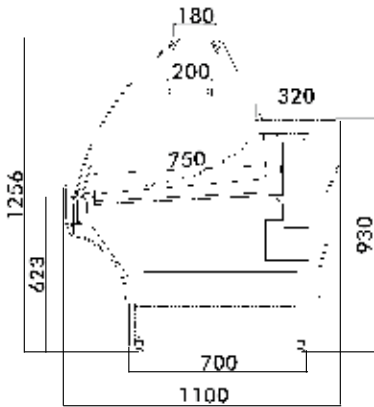

Control Panel



Blue Trim Option



Grey Trim Option



Tamega 2m Curved Glass Red



IMPORTANT. Multiplexed options available, can be multiplexed to all Tamega models with corner unit. Full height divider available for temperature separation. Please check door width/site access before ordering. Additional charges apply for unpack and installation. Please refer to sales office for further information.

MODEL	Description	Price	Trim Colour Options:-
TAMEGA MEAT 15C	White	£2574	Grey
TAMEGA MEAT 20C	White	£3156	Blue
TAMEGA MEAT 25C	White	ORDER £3664	Red
TAMEGA MEAT 30C	White	ORDER £4237	Ceramic tiles still available on request

CHILLED DISPLAY

Tamega Pastry

Serve-over Counter for Patisserie



Features and Benefits

- * Fully Automatic Operation
- * Electronically Controlled
- * Switchable Interior Light
- * Digital Temperature Display
- * 2 Intermediate Ambient Shelves as Standard
- * Stainless Steel Interior & Interior Deck
- * Multiplexable Runs Available (Factory Order Only)
- * Separately Controlled Deck and Storage Compartments
- * 13 amp Socket fitted
- * Marble rear shelf
- * Suitable for up to 25°C Ambient at 65% RH

Technical Specifications

Temperature Range +2/+6°C

Refrigerant R134A

Type of Defrost Off Cycle

Exterior Finish White (gold coloured trim)

Interior Finish Stainless Steel

Power Required 13 Amp Supply

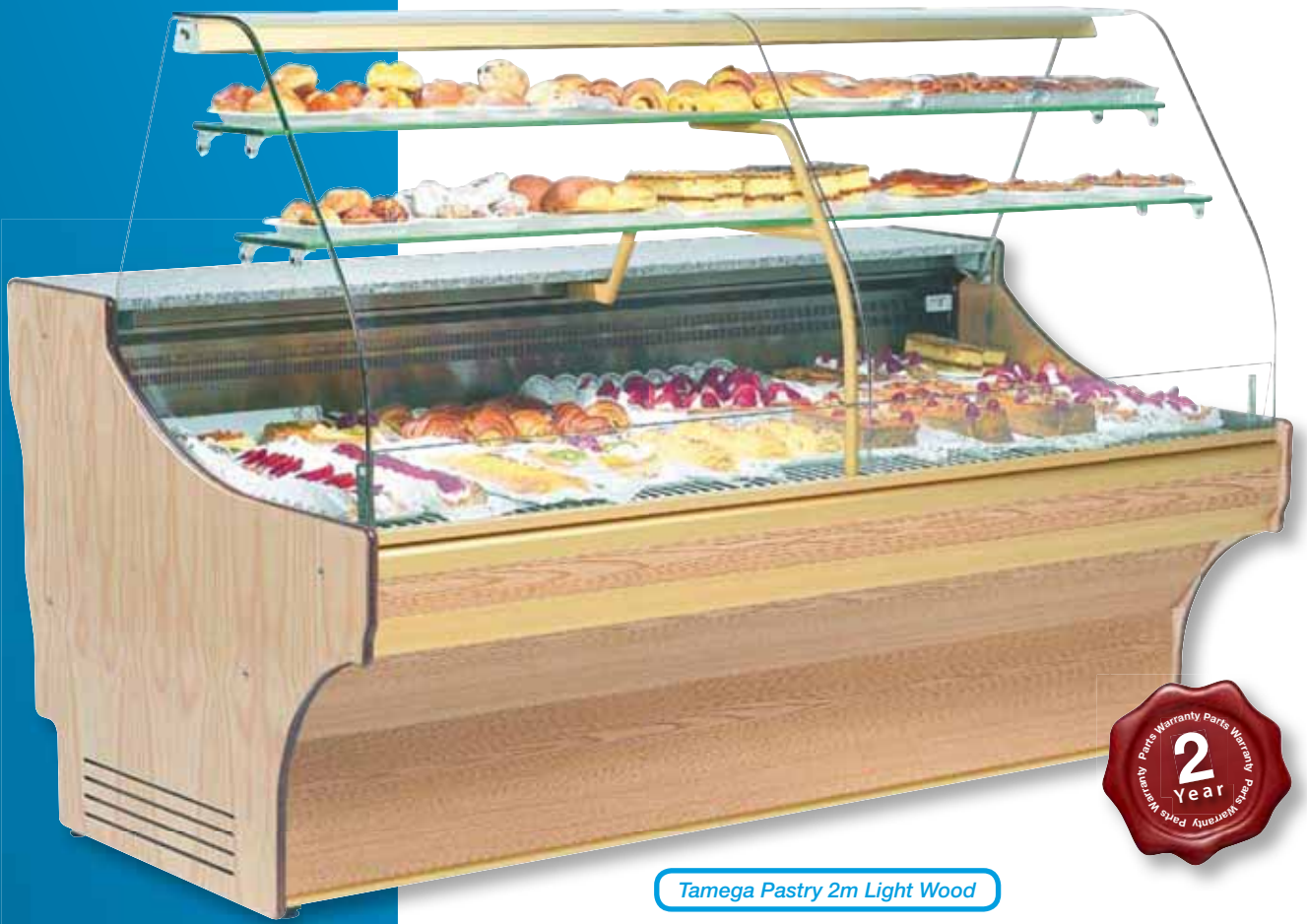
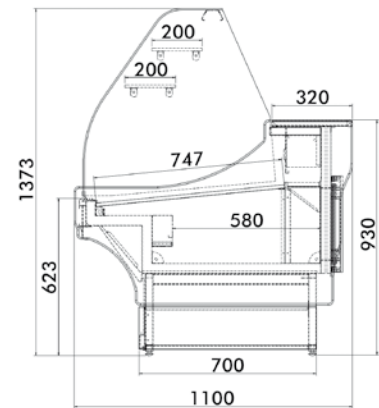

Tamega Pastry 2m Light Wood



Dimensions	Height:	Width:	Depth:	Weight:	Display Area:
1500	1373mm	1430mm	1100mm	270kg	1.5m / 1.099m ²
2000	1373mm	1930mm	1100mm	340kg	2.0m / 1.492m ²
2500	1373mm	2430mm	1100mm	405kg	2.5m / 1.884m ²
3000	1373mm	2930mm	1100mm	510kg	3.0m / 2.198m ²

CHILLED DISPLAY



Tamega Pastry

Serve-over Counter for Patisserie



Tamega Pastry 2m Dark Wood

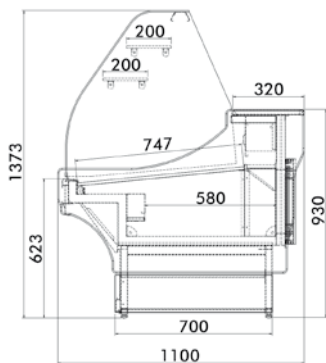

Rear doors to under storage



Control Panel

IMPORTANT. Multiplexed runs of Tamega are factory order only. Reduction for end walls and multiplexing kit are included in the price of the corner unit. Please check door width/site access before ordering. Additional charges apply for unpack and installation. Please refer to sales office for further information.

MODEL	Description	Price	MODEL	Description	Price
TAMEGA PASTRY 15	Wood	£2396	TAMEGA PASTRY 25	Wood	£3355
TAMEGA PASTRY 20	Wood	£2889	TAMEGA PASTRY 30	Wood	£3907
	Finish options			Light or Dark Wood	

CHILLED DISPLAY



Tejo Range

Serveover Counter for Patisserie



Tejo 1.5m in Wood



Slide out rear decks

Features and Benefits

- * Fully Automatic Operation
- * Slide Out Rear Decks for Ease of Loading/Cleaning
- * Electronically Controlled
- * Switchable Interior Light
- * Digital Temperature Display
- * Stainless Steel Interior
- * Marble Rear Shelf
- * Downlighter to front trim as Standard
- * Loading Drawers
- * N.B No Understorage
- * Suitable for up to 25°C Ambient at 65% RH
- * Deck and Shelf Refrigerated. Shelf 2 and 3 Ambient

Technical Specifications

Temperature Range . . . +4°C +12°C
 Refrigerant R134A
 Type of Defrost Off Cycle
 Exterior Finish White/Wood
 Interior Finish Stainless
 Power Required 13 Amp Supply



Tejo 2m



Dimensions	Height:	Width:	Depth:	Weight:	Drawers:
TEJO 15C	1295mm	1450mm	980mm	224kg	2
TEJO 20C	1295mm	2100mm	980mm	270kg	3
TEJO 30C	1295mm	2750mm	980mm	320kg	4

MODEL	Description	Price	MODEL	Description	Price
TEJO 15	White/Gold	£2098	TEJO 15	Wood	£2143
TEJO 20	White/Gold	£2902	TEJO 20	Wood	£2969
TEJO 30	White/Gold	£3692	TEJO 30	Wood	£3791



CHILLED DISPLAY

Fresco

Low Height Multideck

Features and Benefits

- * Illuminated Canopy
- * Fully Automatic Operation
- * Switchable Interior Light
- * Digital Thermometer
- * Fan Assisted Cooling
- * Adjustable Shelving
- * Shelf Ticket Strips
- * Fitted Night Blind
- * Can be Multiplexed (Factory Order)
- * Suitable for up to 25°C Ambient at 65% RH
- * Adjustable Temperature

Technical Specifications

Temperature Range +3/+7°C
Refrigerant R134A
Type of Defrost Off Cycle
No. of Shelves 3
Exterior Finish White
Interior Finish White
Power Required 13 Amp Supply

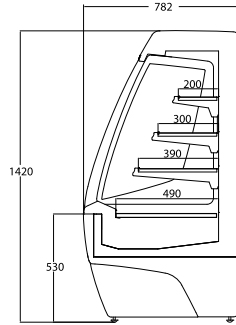

Fresco 100

Dimensions	Height:	Width:	Depth:	Weight:
FRESCO 70	1420mm	705mm	782mm	156kg
FRESCO 100	1420mm	1017mm	782mm	173kg
FRESCO 130	1420mm	1330mm	782mm	241kg

MODEL	Description	Price	MODEL	Description	Price
FRESCO 70	White	£1714	FRESCO 130	White	£2262
FRESCO 100	White	£1930			

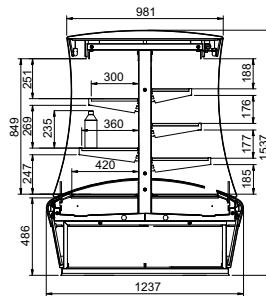

Smart Twin

Walkaround Multideck

Features and Benefits

- * Fully Automatic Operation
- * Adjustable Temperature
- * Fan Assisted Cooling
- * Switchable Interior Lights
- * Night Blinds
- * Digital Controller
- * Digital Temperature Display
- * Adjustable Shelving

Technical Specifications

Temperature Range +2/+10°C
Refrigerant R134A
Type of Defrost Off Cycle
No. of Shelves 6 (3 per side)
Exterior Finish Grey/Glass
Interior Finish Grey/Glass
Power Required 13 Amp Supply

Dimensions	Height:	Width:	Depth:	Weight:	Display Area:
Smart Twin	1537mm	1017mm	1237mm	250kg	2.36m ²

MODEL	Description	Price
Smart Twin	Grey	£5549



CHILLED DISPLAY

Brina

Slimline Multideck



Features and Benefits

- * Fully Automatic Operation
- * Switchable Interior Light
- * Fan Assisted Cooling
- * Adjustable Shelving
- * Capacity 315 x 500ml Bottles
- * Suitable for up to 25°C Ambient at 65% RH
- * Adjustable Temperature

Technical Specifications

Temperature Range +4°C / +12°C
 Refrigerant R404A
 Type of Defrost Electronic
 No. of Shelves Base +3
 Exterior Finish White
 Interior Finish White
 Power Required 13 Amp Supply



Brina 100

Dimensions	Height:	Width:	Depth:	Weight:
BRINA 100	1975mm.	1100mm	675mm	170kg

MODEL	Description	Price
BRINA 100	White	£1599

CHILLED DISPLAY



Features and Benefits

- * Fan Assisted Cooling
- * Fully Automatic Operation
- * Digital Temperature Display
- * Nightblind
- * Switchable Interior Lights
- * Suitable for up to 25°C Ambient at 65% RH
- * Adjustable Temperature

Technical Specifications

Temperature Range . . . +1/+7°C
 Refrigerant R134A
 Type of Defrost Hot Gas
 No. of Shelves Base +4
 Exterior Finish White/Grey
 Interior Finish White
 Power Required 13 Amp Supply



JELKA 130

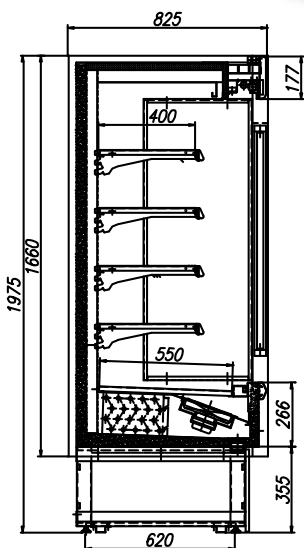

Dimensions	Height:	Width:	Depth:	Weight:
JELKA 100	1975mm	1028mm	825mm	165kg
JELKA 130	1975mm	1340mm	825mm	220kg
JELKA 150	1975mm	1500mm	825mm	275kg
SHELF			400mm	

MODEL	Description	Price	MODEL	Description	Price
JELKA 100	White/Grey	£1841	JELKA 150	White/Grey	£2339
JELKA 130	White/Grey	£1999			

Petite

Slimline Multideck



Features and Benefits

- * Fully Automatic Operation
- * Switchable Interior Light
- * Temperature Display
- * Fan Assisted Cooling
- * Fully Adjustable Cantilever Shelving
- * Shelf Ticket Strips
- * Fitted Night Blind
- * Suitable for up to 25°C Ambient at 65% RH
- * Adjustable Temperature

Technical Specifications

- Temperature Range** +4/+8°C
Refrigerant R404A
Type of Defrost Off Cycle
No. of Shelves Base +4
Exterior Finish White
Interior Finish White
Power Required 13 Amp Supply

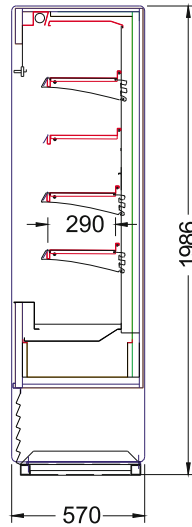

Petite 600



Petite 900



Nightblind

Dimensions	Height:	Width:	Depth:
PETITE 600	1986mm	665mm	570mm
PETITE 900	1986mm	965mm	570mm
PETITE 1200	1986mm	1265mm	570mm
Shelf			290mm

MODEL	Description	Price	MODEL	Description	Price
PETITE 600	White	£1999	PETITE 1200	White	£2788
PETITE 900	White	£2446			

CHILLED DISPLAY

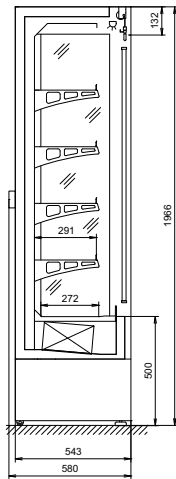

SL190SS

SL Range

Slimline Stainless Steel Multideck

Features and Benefits

- * Fully Automatic
- * Fan Assisted Cooling
- * Mirror Stainless Steel Finish
- * Digital Temperature Display and Controller
- * Interior Lighting
- * Adjustable Cantilever Shelving
- * Ticket Strips
- * Nightblind

Technical Specifications

Temperature Range +2/+8°C
Refrigerant R134A
Type of Defrost Off Cycle
No. of Shelves Base +4
Exterior Finish Mirror Stainless,
Interior Finish Mirror Stainless
Power Required

- SL70SS** 13 Amp Supply
- SL100SS** 13 Amp Supply
- SL130SS** 13 Amp Supply
- SL160SS** 20 Amp Supply
- SL190SS** 20 Amp Supply

**Fits 5
500ml
bottles
high**

**Only
580mm
deep**

**Mirror
Stainless
finish**



Dimensions	Height:	Width:	Depth:	Weight:
SL70SS	1970mm	710mm	580mm	115kg
SL100SS	1970mm	1020mm	580mm	162kg
SL130SS	1970mm	1330mm	580mm	206kg
SL160SS	1970mm	1645mm	580mm	241kg
SL190SS	1970mm	1960mm	580mm	298kg

MODEL	Description	Price	MODEL	Description	Price
SL70SS	Stainless	£2349	SL160SS	Stainless	£3358
SL100SS	Stainless	£2631	SL190SS	Stainless	£3935
SL130SS	Stainless	£2951			

CHILLED DISPLAY

Small White

Slimline Multideck



Features and Benefits

- * Fully Automatic Operation
- * Switchable Interior Light
- * Nightblind
- * Temperature Display
- * Adjustable Shelves
- * Adjustable Temperature
- * Suitable for up to 25°C at 65% RH

Technical Specifications

Temperature Range . . . +2/+10°C
Refrigerant R404A
Type of Defrost Off Cycle
No. of Shelves Base + 4
Exterior Finish White/Grey
Interior Finish Grey
Power Required 13 Amp Supply



SMALL 110



SMALL 60



Dimensions	Height:	Width:	Depth:	Weight:
Small 60	2005mm	670mm	580mm	121kg
Small 90	2005mm	970mm	580mm	152kg
Small 110	2005mm	1170mm	580mm	167kg

MODEL	Description	Price	MODEL	Description	Price
Small 60	White/Grey	£1759	Small 110	White/Grey	£2349
Small 90	White/Grey	£1999			

CHILLED DISPLAY



Small Stainless

Slimline Multideck

Features and Benefits

- * Fully Automatic Operation
- * Switchable Interior Light
- * Nightblind
- * Temperature Display
- * Adjustable Shelves
- * Adjustable Temperature
- * Suitable for up to 25°C at 65% RH
- * Stainless Steel

Technical Specifications

Temperature Range . . . +2/+10°C
 Refrigerant R404A
 Type of Defrost Off Cycle
 No. of Shelves Base + 4
 Exterior Finish Stainless Steel
 Interior Finish Stainless Steel
 Power Required 13 Amp Supply



SMALL 90X

Dimensions	Height:	Width:	Depth:	Weight:
Small 60X	2005mm	670mm	580mm	121kg
Small 90X	2005mm	970mm	580mm	152kg
Small 110X	2005mm	1170mm	580mm	167kg

MODEL	Description	Price	MODEL	Description	Price
Small 60X	Stainless Steel	£2099	Small 110X	Stainless Steel	£2939
Small 90X	Stainless Steel	£2519			

CHILLED DISPLAY

RC Range

Wall Site Multideck



Features and Benefits

- * Fully Automatic Operation
- * Fan Assisted Cooling
- * Digital Temperature Display
- * Auto Defrost
- * Nightblind
- * Switchable Interior Light
- * Acrylic Shelf Risers
- * Ticket Strips
- * Adjustable Cantilever Shelving
- * Suitable for up to 25°C Ambient at 65% RH
- * Adjustable Temperature

Technical Specifications

Temperature Range . . . +1/+10°C

Refrigerant R134A

Type of Defrost Electric

No. of Shelves Base +4

Exterior Finish White

Interior Finish White

Power Required

RC 100, RC 130 . . . 13 Amp Supply

RC 160, RC 190 . . . 20 Amp Supply

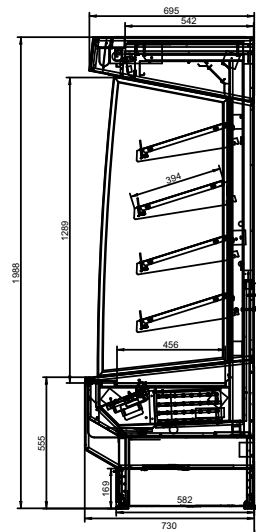

Shelves can be flat or slanted



RC 190



Dimensions	Height:	Width:	Depth:	Weight:
RC 100	1988mm	980mm	790mm	180kg
RC 130	1988mm	1280mm	790mm	230kg
RC 160	1988mm	1580mm	790mm	280kg
RC 190	1988mm	1880mm	790mm	320kg
Shelf			394mm	

MODEL	Description	Price	MODEL	Description	Price
RC 100	White	£2025	RC 160	White	£2693
RC 130	White	£2231	RC 190	White	£2999



RC Range

Wall Site Stainless Steel Multideck

Features and Benefits

- * Fully Automatic Operation
- * Fan Assisted Cooling
- * Digital Temperature Display
- * Auto Defrost
- * Nightblind
- * Switchable Interior Light
- * Acrylic Shelf Risers
- * Ticket Strips
- * Adjustable Cantilever Shelving
- * Suitable for up to 25°C Ambient at 65% RH
- * Adjustable Temperature

Technical Specifications

Temperature Range . . . +1/+10°C

Refrigerant R134A

Type of Defrost Electric

No. of Shelves Base +4 (Stainless)

Exterior Finish Grey

Interior Finish Mirror Stainless

Power Required

RC 100, RC 130 . . . 13 Amp Supply

RC 160, RC 190 . . . 20 Amp Supply



RC 160SS

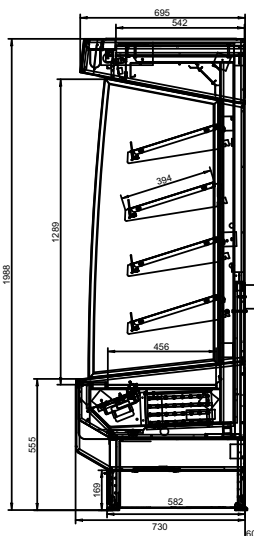

Shelves can be flat or slanted



Dimensions	Height:	Width:	Depth:	Weight:
RC 100SS	1988mm	980mm	790mm	180kg
RC 130SS	1988mm	1280mm	790mm	230kg
RC 160SS	1988mm	1580mm	790mm	280kg
RC 190SS	1988mm	1880mm	790mm	320kg
Shelf		394mm		

Please Note cabinet has a grey exterior and mirrored stainless interior.

MODEL	Description	Price	MODEL	Description	Price
RC 100SS	Grey/Stainless	£2503	RC 160SS	Grey/Stainless	£3232
RC 130SS	Grey/Stainless	£2671	RC 190SS	Grey/Stainless	£3729

CHILLED DISPLAY

Marao

Wall Site Multideck



Features and Benefits

- * Fully Automatic Operation
- * Switchable Interior Light
- * Digital Thermometer
- * Fan Assisted Cooling
- * Multiplexable (Factory Option)
- * Fully Adjustable Cantilever Shelving
- * Shelf Ticket Strips
- * Night Blind
- * Illuminated Canopy
- * Suitable for up to 25°C Ambient at 65% RH
- * Adjustable Temperature

Technical Specifications

Temperature Range . . . +2/+7°C
Refrigerant R134A
Type of Defrost Off Cycle
No. of Shelves 3
Exterior Finish White
Interior Finish White
Power Required 13 Amp Supply
 20 Amp
 Required for
 2.5m Only



Marao 60

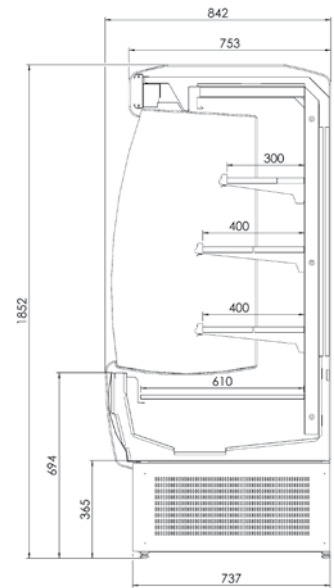

Marao 2m Dairy



Dimensions	Height:	Width:	Depth:	Weight:
MARAO 60	1852mm	600mm	842mm	125kg
MARAO 100	1852mm	1000mm	842mm	195kg
MARAO 120	1852mm	1200mm	842mm	214kg
MARAO 150	1852mm	1500mm	842mm	272kg
MARAO 200	1852mm	2000mm	842mm	342kg
MARAO 250	1852mm	2500mm	842mm	376kg

MODEL	Description	Price	MODEL	Description	Price
MARAO 60	White	£1679	MARAO 150	White	£2494
MARAO 100	White	£1992	MARAO 200	White	£3117
MARAO 120	White	£2228	MARAO 250	White	£3757

CHILLED DISPLAY



Marao

Wall Site Multideck For Fruit & Veg



Marao 2m Fruit & Veg with Nightblind in use



Marao 2m Fruit & Veg

Features and Benefits

- * Fully Automatic Operation
- * Switchable Interior Light
- * Digital Thermometer
- * Fan Assisted Cooling
- * Multiplexable (Factory Option)
- * Night Blind
- * Interior Mirror
- * Illuminated Canopy
- * Suitable for up to 25°C Ambient at 65% RH
- * Adjustable Temperature

Technical Specifications

- Temperature Range +2/+7°C
 Refrigerant R134A
 Type of Defrost Off Cycle
 No. of Baskets
 Marao F10/F12 2
 Marao F15/F20 4
 Exterior Finish White
 Interior Finish White
 Power Required 13 Amp Supply
 20 Amp
 Required for
 2.5m Only



Dimensions	Height:	Width:	Depth:	Weight:
MARAO 100	1852mm	1000mm	842mm	195kg
MARAO 120	1852mm	1200mm	842mm	214kg
MARAO 150	1852mm	1500mm	842mm	272kg
MARAO 200	1852mm	2000mm	842mm	342kg
MARAO 250	1852mm	2500mm	842mm	376kg

MODEL	Description	Price	MODEL	Description	Price
MARAO 100 FRUIT	White	£2106	MARAO 200 FRUIT	White	£3222
MARAO 120 FRUIT	White	ORDER £2324	MARAO 250 FRUIT	White	ORDER £3892
MARAO 150 FRUIT	White	£2726			

CHILLED DISPLAY



Vizela Range

Wall Site Stainless Steel Multideck



Vizela 150 SS



Digital Control Panel

Features and Benefits

- * Fully Automatic Operation
- * Digital Temperature Display
- * Automatic Defrost
- * Night Blind
- * Switchable Interior Light
- * Fully Adjustable Shelving
- * Easy Clean Interior
- * Fan Assisted Cooling
- * Panoramic Glass End Walls
- * Suitable for up to 25°C Ambient at 65% RH
- * Adjustable Temperature

Technical Specifications

Temperature Range. +2 /+7°C
 Refrigerant R134A
 Type of Defrost Electric
 No. of Shelves 4
 Exterior Finish Stainless Steel
 Interior Finish Stainless Steel
 Power Required 13 Amp Supply
 2m Requires
 20 Amp Supply



Dimensions	Height:	Width:	Depth:	Weight:
VIZELA 100	2000mm	990mm	752mm	202kg
VIZELA 130	2000mm	1290mm	752mm	236Kg
VIZELA 150	2000mm	1490mm	752mm	268kg
VIZELA 200	2000mm	1990mm	752mm	340kg

MODEL	Description	Price	MODEL	Description	Price
VIZELA 100SS	Stainless Steel	£2391	VIZELA 100SS FRUIT	Stainless Steel	ORDER £2487
VIZELA 130SS	Stainless Steel	£2679	VIZELA 130SS FRUIT	Stainless Steel	ORDER £2754
VIZELA 150SS	Stainless Steel	£3024	VIZELA 150SS FRUIT	Stainless Steel	ORDER £3088
VIZELA 200SS	Stainless Steel	£3549	VIZELA 200SS FRUIT	Stainless Steel	ORDER £3637

CHILLED DISPLAY

AV Range

Wall Site Multideck



Features and Benefits

- * Fully Automatic Operation
- * Fan Assisted Cooling
- * Digital Temperature Display
- * Auto Defrost
- * Nightblind
- * Switchable Interior Light
- * Ticket Strips
- * Fully Adjustable Cantilever Shelving
- * Low Front to maximise display space
- * Suitable for up to 25°C Ambient at 65% RH
- * Adjustable Temperature

Technical Specifications

Temperature Range . . . +1/+10°C

Refrigerant R134A

Type of Defrost Electric

No. of Shelves Base +4

Exterior Finish White

Interior Finish White

Power Required

AV100, A130 13 Amp Supply

AV160 20 Amp Supply



Fits 5
500ml
bottles
high

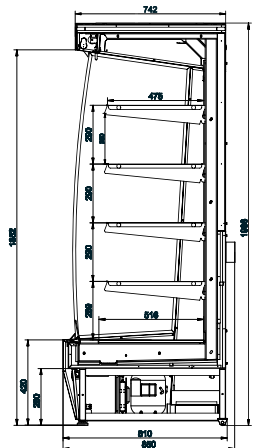

Dimensions	Height:	Width:	Depth:
AV 100	1980mm	994mm	850mm
AV 130	1980mm	1285mm	850mm
AV 160	1980mm	1585mm	850mm

MODEL	Description	Price	MODEL	Description	Price
AV 100	White	£2489	AV 160	White	£3408
AV 130	White	£2686			





Shelly Range

Wall Site Multideck

Features and Benefits

- * Fully Automatic Operation
- * Switchable Interior Light
- * Automatic Defrost
- * Night Blind
- * Adjustable Shelving
- * Fan Assisted Cooling
- * Panoramic Glass End Walls and Front Panel
- * Shelf Risers Optional Extra (P.O.A.)
- * Ticket Strips Optional Extra (P.O.A.)
- * Suitable for up to 25°C Ambient at 65% RH
- * Adjustable Temperature

Technical Specifications

Temperature Range . . . 0/+2°C

Refrigerant R404A

Type of Defrost Electric

No. of Shelves

Shelly 120/180 4

Shelly 240 8

Exterior Finish White

Interior Finish White

Power Required 20 Amp supply

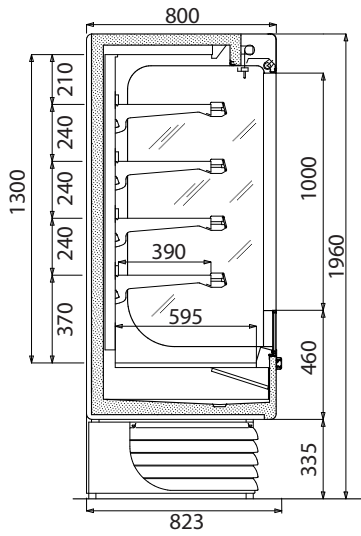

Shelly 240

Dimensions	Height:	Width:	Depth:	Weight:
SHELLY 120	1960mm	1300mm	823mm	266kg
SHELLY 180	1960mm	1895mm	823mm	310kg
SHELLY 240	1960mm	2490mm	823mm	370kg

MODEL	Description	Price	MODEL	Description	Price
SHELLY 120	White	£3299	SHELLY 240	White	£5059
SHELLY 180	White	£3850			

CHILLED DISPLAY

Vouga Range

Wall Site Multideck



Features and Benefits

- * Fan Assisted Cooling
- * Fully Automatic
- * Digital Temperature Display and Controller
- * Nightblind
- * Adjustable Cantilever Shelving
- * Ticket Strips
- * Suitable for up to 25°C Ambient at 65% RH
- * Low Front to maximise display
- * Adjustable Temperature
- * Switchable Interior Light

Technical Specifications

Temperature Range +2/+7°C

Refrigerant R404A

Type of Defrost Off Cycle

No. of Shelves Base +4

Exterior Finish White/Grey

Interior Finish White

Power Required

Vouga 100 13 Amp Supply

Vouga 130 20 Amp Supply

Vouga 200 20 Amp Supply

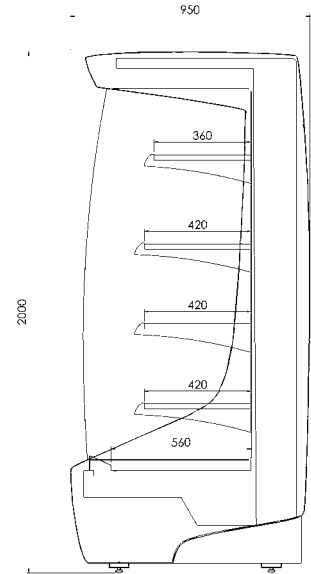

Fits 5 500ml bottles high



Vouga 200

Dimensions	Height:	Width:	Depth:	Weight:
Vouga 100	2000mm	1067mm	950mm	187kg
Vouga 130	2000mm	1380mm	950mm	221kg
Vouga 200	2000mm	2005mm	950mm	298kg

MODEL	Description	Price	MODEL	Description	Price
Vouga 100	White/Grey	£2749	Vouga 200	White/Grey	£4304
Vouga 130	White/Grey	£3354			

CHILLED DISPLAY



Smart Range

Wall Site Multideck

Features and Benefits

- * Fully Automatic Operation
- * Adjustable Temperature
- * Fan Assisted Cooling
- * Nightblind
- * Switchable Interior Light
- * Low Front To Maximise Display Space
- * Suitable for up to 25°C Ambient at 65% RH

Technical Specifications

Temperature Range +2/+8°C
Refrigerant R404
Type of Defrost Off Cycle
No. of Shelves Base + 4
Exterior Finish Grey
Interior Finish White
Power Required 13 Amp Supply

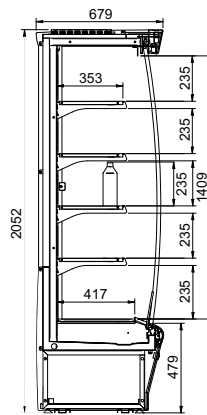

Dimensions	Height:	Width:	Depth:	Weight:	Display Area:
Smart 70MP	2052mm	700mm	680mm	133kg	1.22m ²
Smart 100MP	2052mm	1017mm	680mm	190kg	1.84m ²
Smart 135MP	2052mm	1330mm	680mm	230kg	2.45m ²
Smart 200MP	2052mm	1955mm	680mm	300kg	3.68m ²

MODEL	Description	Price	MODEL	Description	Price
Smart 70MP	Grey	£3199	Smart 135MP	Grey	£3689
Smart 100MP	Grey	£3379	Smart 200MP	Grey	£4583



Argus Range

Wall Site Multideck

Features and Benefits

- * Fully Automatic Operation
- * Adjustable Temperature
- * Fan Assisted Cooling
- * Night Blind
- * Switchable Interior Lights
- * Low Front To Maximise Display Space
- * Suitable for up to 25°C Ambient at 65% RH

Technical Specifications

Temperature Range +2/+8°C
Refrigerant R404
Type of Defrost Off Cycle
No. of Shelves Base + 4
Exterior Finish Grey
Interior Finish White
Power Required 13 Amp Supply
 2m Requires
 2x 13 Amp

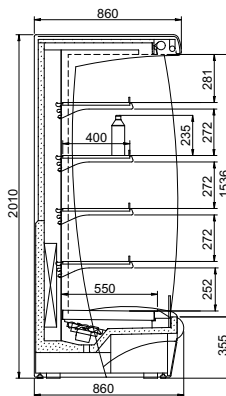

Dimensions	Height:	Width:	Depth:	Weight:
Argus 100 H	2010mm	1017mm	900mm	190kg
Argus 135 H	2010mm	1330mm	900mm	225kg
Argus 200 H	2010mm	1955mm	900mm	300kg

MODEL	Description	Price	MODEL	Description	Price
Argus 100 H	Grey	£3446	Argus 200 H	Grey	£5423
Argus 135 H	Grey	£4329			

CHILLED DISPLAY

Proxima Range

Buffet Display



Features and Benefits

- * Fitted Rollers
- * Electric Hood – One Touch Operation
- * 3/4/6 x 1/1 Gastronorm Pan Options
- * Finblock Evaporator
- * Fully Automatic Operation
- * Switchable Interior Light
- * Easy Clean Interior
- * Gastronorm Pans not Supplied – See Page 184
- * Gastronorm Supports Supplied
- * Digital Temperature Display

Technical Specifications

Temperature Range . . . +3/10°C
 Refrigerant R134A
 Type of Defrost Timed Off Cycle
 No. Pan Supports
 Proxima 3 5 Large
 6 Small
 Proxima 4 7 Large
 8 Small
 Proxima 6 11 Large
 12 Small
 Exterior Finish Wood
 Interior Finish Stainless Steel
 Power Required 13 Amp Supply
 230 Volts



Unit shows optional Head Shelf

Proxima 4



Electric Hood

PROXIMA 3
Weight - 129kg

PROXIMA 4
Weight - 152kg

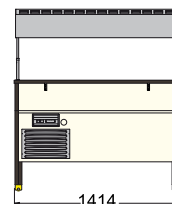
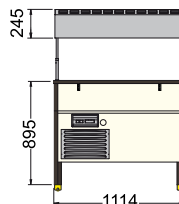

PROXIMA 6
Weight - 180kg

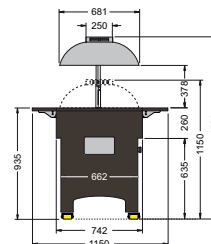
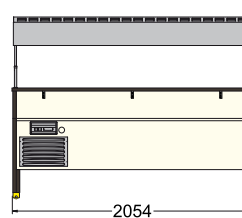

Proxima 6

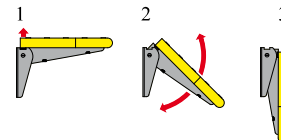

Well Dimensions

	Height:	Width:	Depth:
Proxima 3	150mm	1020mm	530mm
Proxima 4	150mm	1320mm	530mm
Proxima 6	150mm	1960mm	530mm

Head Shelf
(each)
X02373

£110

MODEL	Description	Price	MODEL	Description	Price
Proxima 3	Dark Wood	£2793	Proxima 6	Dark Wood	£3639
Proxima 3	Light Wood	£2793	Proxima 6	Light Wood	£3639
Proxima 4	Dark Wood	£2993			
Proxima 4	Light Wood	£2993			



Proxima Range

Buffet Display

Features and Benefits

- * Fitted Rollers
- * Electric Hood – One Touch Operation
- * 3/4/6 x 1/1 Gastronorm Pan Options
- * Infrared Lamps in Light Canopy
- * Hot Bain Marie or Ceramic Options
- * Switchable Interior Light
- * Digital Temperature Display
- * Gastronorm Pans not Supplied – See Page 184
- * Infrared Lamps
 - Proxima 3 – 2x 300 Watts
 - Proxima 4 – 3x 300 Watts
 - Proxima 6 – 4x 300 Watts

Technical Specifications

Temperature Range. +30/+90°C

No. Pan Supports

- Proxima 3 5 Large
6 Small
- Proxima 4 7 Large
8 Small
- Proxima 6 11 Large
12 Small

Exterior Finish Wood

Interior Finish Stainless Steel

Power Required

- Proxima 3/4 13 Amp Supply
- Proxima 6 3 Phase Supply
Required
415 Volts



Proxima 4 BM LW



Proxima 4 BM DW

PROXIMA 3
Weight - BM 107kg
Weight - CH 87kg

PROXIMA 4
Weight - BM 145kg
Weight - CH 110kg

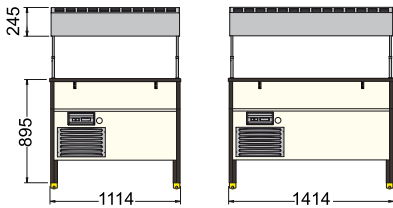

PROXIMA 6
Weight - BM 154kg
Weight - CH 134kg

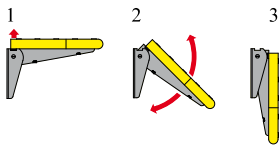
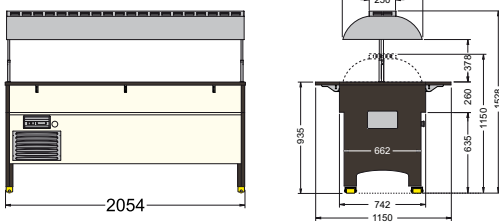

Proxima 4 CH DW

Well Dimensions

	Height:	Width:	Depth:
Proxima 3	150mm	1020mm	530mm
Proxima 4	150mm	1320mm	530mm
Proxima 6	150mm	1960mm	530mm

All Proximas come fitted with Rollers as standard (not pictured)

MODEL	Description	Price	MODEL	Description	Price
Proxima 3 BM DW	Dark Wood	£2919	Proxima 3 CH DW	Dark Wood	£2917
Proxima 3 BM LW	Light Wood	£2919	Proxima 3 CH LW	Light Wood	£2917
Proxima 4 BM DW	Dark Wood	£3193	Proxima 4 CH DW	Dark Wood	£3139
Proxima 4 BM LW	Light Wood	£3193	Proxima 4 CH LW	Light Wood	£3139
Proxima 6 BM DW	Dark Wood	£3897	Proxima 6 CH DW	Dark Wood	£3879
Proxima 6 BM LW	Light Wood	£3897	Proxima 6 CH LW	Light Wood	£3879

Isola

Cold, Ambient

Features and Benefits

- * Fitted Castors
- * Electric Wind Down Top - One Touch Operation
- * 4/6 1/1 Gastronorm Option
- * Solid Wood Construction
- * Finblock Evaporator
- * Fully Automatic Operation
- * Switchable Interior Light
- * Easy Clean Interior
- * Digital Temperature Display
- * Gastronorm Pans not Supplied - See Page 184
- * Gastronorm Support Supplied

Technical Specifications

- Temperature Range** . . . +3/10°C
Refrigerant R134A
Type of Defrost Timed Off Cycle
No. Pan Supports
Isola 4 7 Large
 8 Small
Isola 6 12 Large
 11 Small
Exterior Finish Wood
Interior Finish Stainless Steel
Power Required 13 Amp Supply
 230 Volts



Isola 4 Cold

Light wood



Isola 4 Ambient

Dark wood

ISOLA 4
 Weight - Cold 125kg
 Weight - Amb 103kg

ISOLA 6
 Weight - Cold 162kg

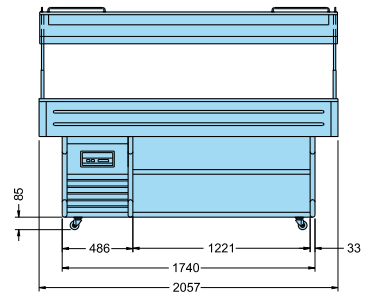
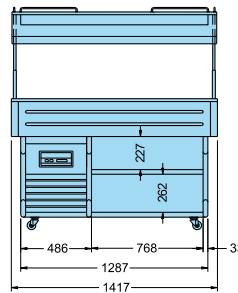

Picture shows optional sliding glass doors
 Isola 4 - £106.00 per side
 Isola 6 - £157.00 per side

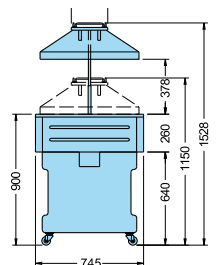

Well Dimensions			
	Height:	Width:	Depth:
4	150mm	1300mm	530mm
6	150mm	1950mm	530mm

MODEL	Description	Price	MODEL	Description	Price
ISOLA 4 DW	Dark Wood	£2709	ISOLA 4 AMB DW	Dark Wood	 £1908
ISOLA 4 LW	Light Wood	£2709	ISOLA 4 AMB LW	Light Wood	 £1908
ISOLA 6 DW	Dark Wood	£3245			
ISOLA 6 LW	Light Wood	£3245			

Features and Benefits

- * Fitted Castors
- * Electric Wind Down Top - One Touch Operation
- * 4/6 1/1 Gastronorm Option
- * Solid Wood Construction
- * Infrared Lamps in Light Canopy
- * Hot Bain Marie or Ceramic Options
- * Fully Automatic Operation
- * Switchable Interior Light
- * Digital Temperature Display
- * Infrared Lamps -
Isola 4-3x300 watts
Isola 6-4x300 watt
- * Gastronorm Pans not Supplied - See Page 184

Technical Specifications

Temperature Range +30/90°C

No. Pan Supports

Isola 4 7 Large
8 Small

Isola 6 12 Large
11 Small

Exterior Finish Wood

Interior Finish Stainless Steel

Power Required 13 Amp Supply

Isola 4 Bain Marie 20 Amp Supply

Isola 6 Bain Marie 3 Phase Supply

Required

415 Volts



Light wood option

Isola 4 Bain Marie

ISOLA 4
Weight - Bain 98kg
Weight - Hot 122kg

ISOLA 6
Weight - Bain 112kg
Weight - Hot 145kg

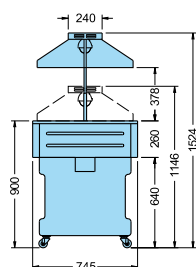
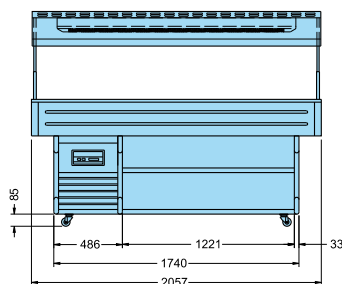
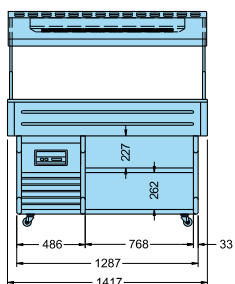

Do not lower canopy until all hot surfaces have cooled.



Isola 4 Hot Plate

Well Dimensions

	Height:	Width:	Depth:
4	150mm	1300mm	530mm
6	150mm	1950mm	530mm

MODEL	Description	Price	MODEL	Description	Price
ISOLA 4 BM DW	Dark Wood	£2899	ISOLA 4 CH DW	Dark Wood	£2918
ISOLA 4 BM LW	Light Wood	£2899	ISOLA 4 CH LW	Light Wood	£2918
ISOLA 6 BM DW	Dark Wood	£3567	ISOLA 6 CH DW	Dark Wood	£3524
ISOLA 6 BM LW	Light Wood	£3567	ISOLA 6 CH LW	Light Wood	£3524

Isola Elite

Bain Marie, Hot Plate

Features and Benefits

- * Fitted Castors
- * Electric Wind Down Top - One Touch operation
- * 4/6 1/1 Gastronorm Option
- * Solid Wood Construction
- * Infrared Lamps in Light Canopy
- * Hot Bain Marie or Ceramic Option
- * Stainless Steel Trayslides Fitted as Standard
- * Fully Automatic Operation
- * Switchable Interior Light
- * Easy Clean Interior
- * Digital Temperature Display
- * Infrared Lamps -
Isola 4-3x300 watts
Isola 6-4x300 watts
- * Gastronorm Pans not Supplied - See Page 184

Technical Specifications

Temperature Range +30/90°C

No. Pan Supports

Isola Elite 4 7 Large
8 Small

Isola Elite 6 12 Large
11 Small

Exterior Finish Wood

Interior Finish Stainless Steel

Power Required 13 Amp Supply

Isola 4 Bain Marie 20 Amp Supply

Bain Marie 6/1 3 Phase Supply

Required
415 Volts



Pictures show optional sliding glass doors
Isola 4 - £106.00 per side
Isola 6 - £157.00 per side

Isola Elite Bain Marie

ISOLA 4
Weight - Bain 108kg
Weight - Hot 132kg

ISOLA 6
Weight - Bain 127kg
Weight - Hot 160kg

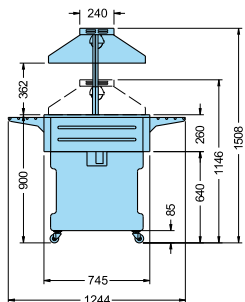
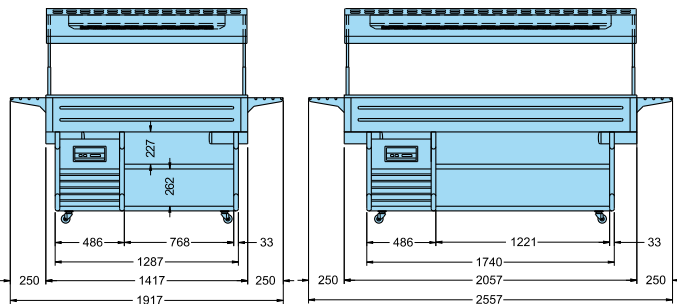

Do not lower canopy until all hot surfaces have cooled.



Light wood option

Isola Elite Hot Plate

Well Dimensions

	Height:	Width:	Depth:
4	150mm	1300mm	530mm
6	150mm	1950mm	530mm

MODEL	Description	Price	MODEL	Description	Price
ISOLA 4 BM ELITE DW	Dark Wood	£3354	ISOLA 4 CH ELITE DW	Dark Wood	ORDER £3209
ISOLA 4 BM ELITE LW	Light Wood	£3354	ISOLA 4 CH ELITE LW	Light Wood	ORDER £3209
ISOLA 6 BM ELITE DW	Dark Wood	£4098	ISOLA 6 CH ELITE DW	Dark Wood	ORDER £3997
ISOLA 6 BM ELITE LW	Light Wood	ORDER £4098	ISOLA 6 CH ELITE LW	Light Wood	ORDER £3997

Isola System

Multiplexed Buffet



Gastronorm pans available (P.O.A.)
See p184



Control Panel

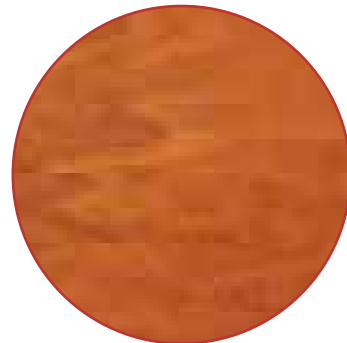

Light wood



Isola System

Optional Sliding Glass Doors
Isola 4 - £106.00 per side
Isola 6 - £157.00 per side

System options cannot be retro fitted and must be ordered with cabinet

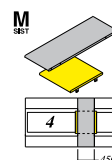

Intermediate shelf - £251.00

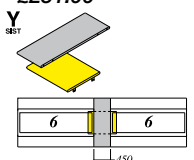
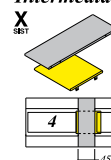



45° angular corner - £289.00

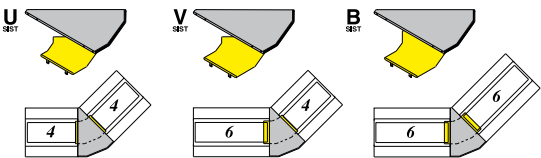

90° angular corner - £349.00

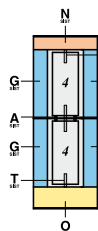
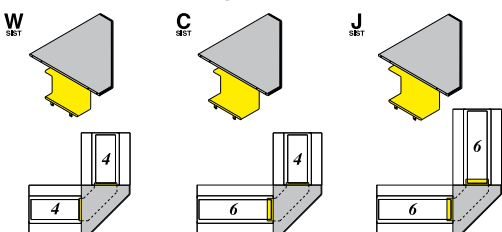

A
Multiplexing kit £46.00

G
Shelf for Mod. 4 £174.00

H
Shelf for Mod. 6 £189.00

N
Head short shelf £150.00

O
Head long shelf £204.00



Isola SS System



Murale Wall Site System

Murale

Wallsite Display

Features and Benefits

- * Auto Defrost
- * Fitted Castors
- * Electric Wind Down Top
- * 4 or 6 1/1 Gastronorm Options
- * Solid Wood Construction
- * Fully Automatic Operation
- * Switchable Interior Light
- * Digital Temperature Display
- * Gastronorm Pans not Supplied - See Page 184

Technical Specifications

Temperature Range	+3/10°C
Refrigerant	R134A
Type of Defrost	Timed Off Cycle
No. Pan Supports	
Murale 4	7 Large 8 Small
Murale 6	12 Large 11 Small
Exterior Finish	Wood
Interior Finish	Stainless Steel
Power Required	13 Amp Supply



MURALE 4
Weight - 160kg

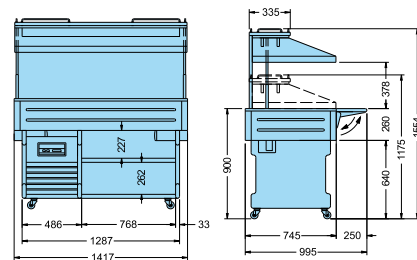

MURALE 6
Weight - 175kg

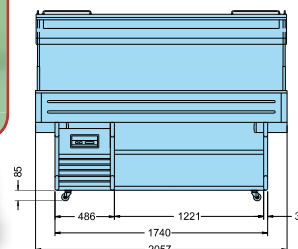

Well Dimensions	Height:	Width:	Depth:
4	150mm	1300mm	530mm
6	150mm	1950mm	530mm

MODEL	Description	Price	MODEL	Description	Price
MURALE 4 DW	Dark Wood	£3310	MURALE 6 DW	Dark Wood	£3856
MURALE 4 LW	Light Wood	£3310	MURALE 6 LW	Light Wood	£3856

Monterrey

Wallsite Display

Features and Benefits

- * Solid Wood Construction
- * Fitted Castors
- * Fan Assisted Cooling
- * Sliding Glass Doors
- * 2 Shelves as Standard
- * Fully Automatic Operation
- * Switchable Interior Light
- * Digital Temperature Display
- * Cutlery Drawers as Standard
- * Door Lock on Sliding Glass Doors - Optional Extra
- * Gastronorm Pans not Supplied - See Page 184

Technical Specifications

Temperature Range	+3/10°C
Refrigerant	R134A
Type of Defrost	Off Cycle
No. of Shelves	2 per side
Exterior Finish	Wood
Interior Finish	Stainless Steel
Power Required	13 Amp Supply



Monterrey



MONTERREY
Weight - 225kg

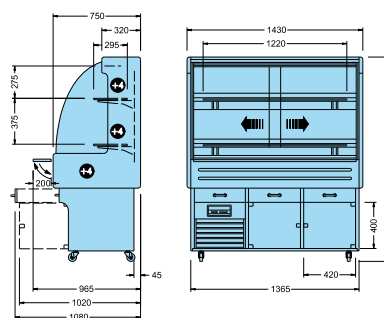

MODEL	Description	Price	MODEL	Description	Price
MONTERREY DW	Dark Wood	£4199	MONTERREY LW	Light Wood	£4199

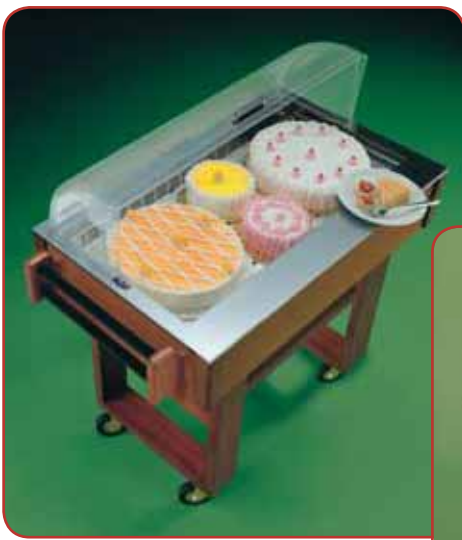

Carello

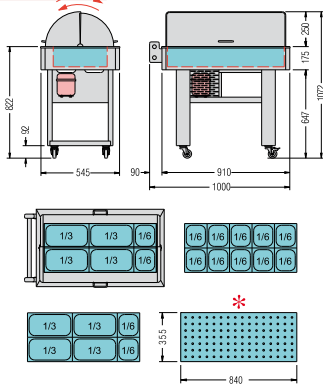

Carello with Pans



Features and Benefits

- * Easy Access Unit Compartment for Service and Maintenance
- * Manual Defrost
- * Solid Wood Construction
- * Fitted Castors
- * Finblock Evaporator
- * Suitable for Gastronorm Pans (Not Supplied) see page 184

Technical Specifications

Temperature Range +4/+10°C
 Refrigerant R134A
 Type of Defrost Manual
 Exterior Finish Wood
 Interior Finish Stainless Steel

MODEL	Description	Price
Carello	Wood Finish	£1499

Carrettino 10/250

Sweet Trolleys



CARRETTINO 10
Weight - 80kg

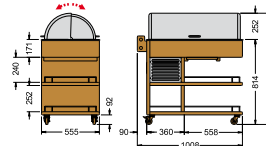

Carrettino 250

Carrettino 10

CARRETTINO 250
Weight - 115kg

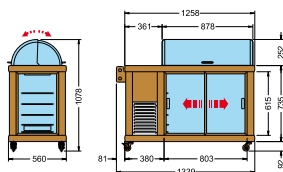

Features and Benefits

- * Easy Access Unit Compartment for Service and Maintenance
- * Auto Defrost 250 (manual defrost 10)
- * Solid Wood Construction
- * Fitted Castors
- * Fully Adjustable Shelving (250 only)
- * Finblock Evaporators
- * 2 Shelves as Standard (250 only)
- * Fully Automatic Operation
- * Digital Temperature Display
- * Suitable for Gastronorm Pans (Not Supplied) see page 184

Technical Specifications

Temperature Range +3/10°C
 Refrigerant R134A
 Type of Defrost Timed Off Cycle
 No. of Shelves 2 (250 only)
 Exterior Finish Wood
 Interior Finish Stainless Steel
 Power Required 13 Amp Supply

Carrettino 10 Well Dimensions		
Height	Width	Depth
145mm	840mm	365mm

MODEL	Description	Price	MODEL	Description	Price
CARRETTINO 10 DW	Dark Wood	£1767	CARRETTINO 250 DW	Dark Wood	£2455
CARRETTINO 10 LW	Light Wood	£1767	CARRETTINO 250 LW	Light Wood	£2455

Prisma Gold

Glass Display

Features and Benefits

- * Castors
- * Auto Defrost
- * Fully Adjustable Shelving -
R = rotating shelves
Q = Wire Shelves
- * 5 Shelves as Standard - 400
- * 5 + 5 Supplied on 800
- * Fully Automatic Operation
- * Switchable Interior Light
- * Digital Temperature Display
- * Replaceable Door Gasket
- * Adjustable Temperature

Technical Specifications

Temperature Range +4 /+10°C
Refrigerant R404A
Type of Defrost Timed Off Cycle
No. of Shelves
Prisma 400 5
Prisma 800 5 + 5
Exterior Finish Gold Anodised
 Aluminium &
 Glass
Interior Finish Aluminium/Glass
Power Required 13 Amp Supply



Prisma R Rotating Shelves



Prisma Q Wire Shelves



Prisma 800 RQ



PRISMA 400 R/Q
Capacity 400 ltr. (14.1cu.ft.) 168kg

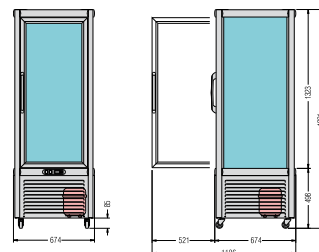

PRISMA 800 RQ
Capacity 800 ltr. (14.1cu.ft.) 168kg

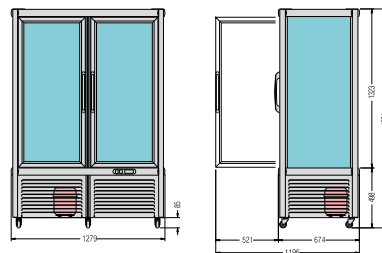

Rotating Shelves
(Prisma R)



Control Panel

Not Suitable for Chocolates

MODEL	Description	Price	MODEL	Description	Price
PRISMA 400 Q	Gold	£1503	PRISMA 800 RQ	Gold	£2434
PRISMA 400 R	Gold	£1564			



Prisma Silver

Glass Display

Features and Benefits

- * Castors
- * Auto Defrost
- * Fully Adjustable Shelving -
R = rotating shelves
Q = Wire Shelves
- * 5 Shelves as Standard - 400
- * 5 + 5 Supplied on 800
- * Fully Automatic Operation
- * Switchable Interior Light
- * Digital Temperature Display
- * Replaceable Door Gasket
- * Adjustable Temperature

Technical Specifications

Temperature Range	+4/+10°C
Refrigerant	R404A
Type of Defrost	Timed Off Cycle
No. of Shelves	
Prisma 400	5
Prisma 800	5 + 5
Exterior Finish	Silver Anodised Aluminium & Glass
Interior Finish	Aluminium/Glass
Power Required	13 Amp Supply



Prisma Q Wire Shelves



Prisma R Rotating Shelves

PRISMA 400 R/Q
Capacity 400 ltr. (14.1cu.ft.) 168kg

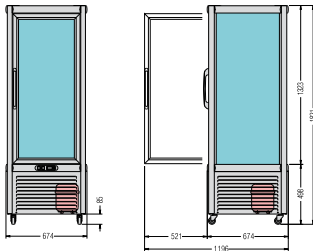

PRISMA 800 RQ
Capacity 800 ltr. (14.1cu.ft.) 168kg

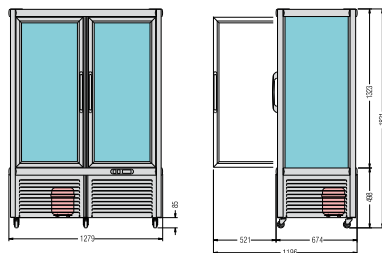

Rotating Shelves
(Prisma R)



Control Panel



Prisma 800 RQ

Not Suitable for Chocolates

MODEL	Description	Price	MODEL	Description	Price
PRISMA 400 Q	Silver	£1503	PRISMA 800 RQ	Silver	£2434
PRISMA 400 R	Silver	£1564			

ORDER

Continental

Glass Display

Features and Benefits

- * Castors
- * Auto Defrost (not 400 GBT Manual)
- * Fan Assisted Cooling (400 GBT Static Cooling)
- * Adjustable Shelving - Except 400 GBT with 6 Static Cooled Shelves)
- * Fully Automatic Operation
- * Switchable Interior Lights
- * Temperature Display
- * Replaceable Door Gaskets
- * Anti Mist Glass
- * Reversible Door Factory Order Only

Technical Specifications

Temperature Range +3/10°C (R/G/Q)
 -5/-20°C (GBT)

Refrigerant R134A
 R404A-(400 GBT)

Type of Defrost Timed Off Cycle (400 GBT Manual)

No. of Shelves 5/6 on 400 GBT

Exterior Finish Coloured Anodised Aluminium

Interior Finish Glass/Aluminium

Power Required 13 Amp Supply



Continental 350 R Rotating Display



Continental 350 G Glass Shelves



Continental 350 Q Wire Shelves



Continental 400 GBT Static Freezer



Dimensions	Height:	Width:	Depth:	Weight:	Capacity:
CONTINENTAL 350 R/G/Q	1810mm	595mm	615mm	153kg	350ltr. (12.3cu.ft.)
CONTINENTAL 400 GBT	1815mm	595mm	615mm	163kg	400ltr. (14.1cu.ft.)

Not Suitable for Chocolates
 Chocolate Version Available P.O.A

MODEL	Description	Price	MODEL	Description	Price
CONTINENTAL 350 R	Aluminium	£1623	CONTINENTAL 350 Q	Aluminium	£1572
CONTINENTAL 350 G	Aluminium	£1572	CONTINENTAL 400 GBT	Aluminium	£1938

Continental

Glass Display



*Continental 700 R
Rotating Display*



*Continental 700 G
Glass Shelves*



*Continental 700 Q
Wire Shelves*



*Continental 700 RQ
Rotating/Wire Shelves*

Features and Benefits

- * Fitted Castors
- * Auto Defrost
- * Fan Assisted Cooling
- * Adjustable Shelving - Fixed Positions 700R & RQ
- * Fully Automatic Operation
- * Switchable Interior Light
- * Temperature Display
- * Replaceable Door Gaskets
- * Anti Mist Glass

Technical Specifications

Temperature Range +3/10°C (R/G/Q)
Refrigerant R134A
Type of Defrost Timed Off Cycle
No. of Shelves 5 per side / 6 on 700 R
Exterior Finish Coloured Anodised Aluminium
Interior Finish Glass/Aluminium
Power Required 13 Amp Supply



Dimensions	Height:	Width:	Depth:	Weight:	Capacity:
CONTINENTAL 700	1810mm	1145mm	615mm	246kg	700ltr. (24.7cu.ft.)

Not Suitable for Chocolates

MODEL	Description	Price	MODEL	Description	Price
CONTINENTAL 700 R	Aluminium	£2899	CONTINENTAL 700 G	Aluminium	£2682
CONTINENTAL 700 R/Q	Aluminium	£2789	CONTINENTAL 700 Q	Aluminium	£2688

CATERING & RESTAURATEURS DISPLAY

Micron

Glass Display

Features and Benefits

- * Fan Assisted Cooling
- * Adjustable Shelving
- * Adjustable Feet
- * 2 Shelves as Standard (Except Micron III which has 3)
- * Fully Automatic Operation
- * Temperature Display
- * Replaceable Door Gaskets
- * Interior Light

Technical Specifications

Temperature Range . . . +4/+10°C
Refrigerant R134A
Type of Defrost Off Cycle
No. of Shelves 2/3
Exterior Finish White
Interior Finish White Plastic
Power Required 13 Amp Supply



Micron I



Micron II



Micron III

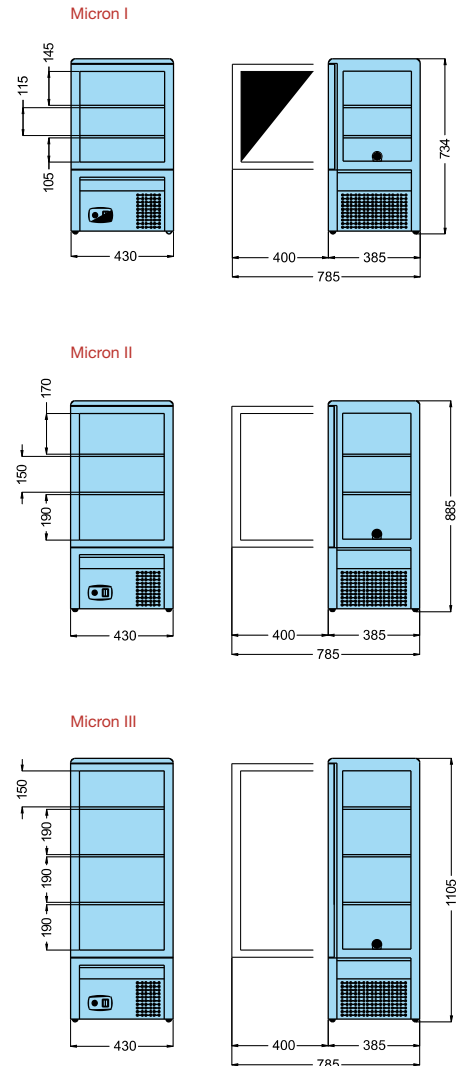

Dimensions	Height:	Width:	Depth:	Weight:	Capacity:
MICRON I	734mm	430mm	385mm	34kg68ltr. (2.4cu.ft.)
MICRON II	885mm	430mm	385mm	37kg93ltr. (3.28cu.ft.)
MICRON III	1105mm	430mm	385mm	42kg	1.20ltr. (4.24cu.ft.)

MODEL	Description	Price	MODEL	Description	Price
MICRON I	White	£899	MICRON III	White	£999
MICRON II	White	£919			

CATERING & RESTAURATEURS DISPLAY



Bella Range

Glass Display

Features and Benefits

- * Fitted Castors
- * Auto Defrost
- * Fan Assisted Cooling
- * Adjustable Shelving – G Model Only
- * Fully Adjustable Operation
- * Switchable Interior Light
- * Digital Temperature Display
- * Replaceable Door Gaskets
- * Reversible Door Factory Order Only
- * LED Internal Lighting

Technical Specifications

Temperature Range +4/+10°C
Refrigerant R134A
Type of Defrost Timed Off Cycle
No. of Shelves 5/6 on R Model
Exterior Finish Coloured Anodised Aluminium
Interior Finish Glass/Aluminium
Power Required 13 Amp Supply



Bella R

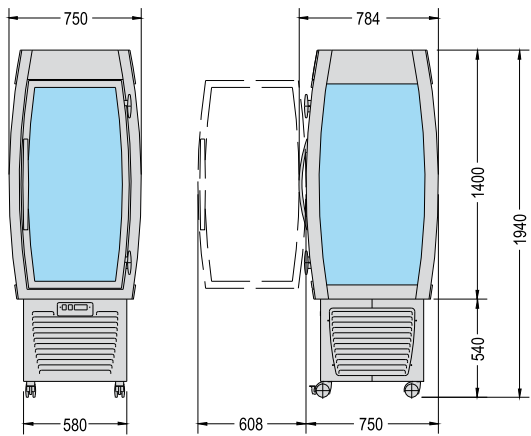

Bella G



Not suitable for Chocolates
 Chocolate Version Available P.O.A.

Dimensions	Height:	Width:	Depth:	Weight:	Capacity:
External					
Bella	1940mm	750mm	784mm	145kg	570ltr. (20.1cu.ft.).

MODEL	Description	Price	MODEL	Description	Price
Bella R	Aluminium	£3755	Bella G	Aluminium	£3789

CATERING & RESTAURATEURS DISPLAY

Minimax

Counter Top Displays

Features and Benefits

- * Auto Defrost (Manual on Q GBT)
- * Fan Assisted Cooling
- * Adjustable Shelving (except Hot and GBT Which are fixed)
- * Adjustable Feet
- * Fully Automatic Operation
- * Interior Lights
- * Temperature Display
- * Replaceable Door Gaskets
- * Ceramic Heater Tubes to Hot Version

Technical Specifications

Temperature Range . . . +4/10°C
 -5/-18°C Q GBT
 +35/+80°C Hot

Refrigerant R134A

Type of Defrost Timed Off Cycle
 Q GBT Manual

No. of Shelves 2

Exterior Finish Coloured
 Anodised
 Aluminium

Interior Finish Glass

Power Required 13 Amp Supply



Minimax Q

Sliding door to rear only



Minimax Q SS

Self Service: Sliding Door to rear, flaps at front



Minimax Q HOT



Minimax Q AMB

Sliding doors to rear, flaps to front



Minimax Q GBT

Freezer - Hinged doors to rear only

Dimensions	Height:	Width:	Depth:	Weight:	Capacity:
External					
MINIMAX 200 Q	715mm	1200mm	500mm	91kg	200ltr. (7cu.ft.)
MINIMAX 200 Q SS	715mm	1200mm	500mm	82kg	200ltr. (7cu.ft.)
MINIMAX 200 Q HOT	715mm	900mm	500mm	45kg	200ltr. (7cu.ft.)
MINIMAX 200 Q AMB	715mm	900mm	500mm	60kg	200ltr. (7cu.ft.)
MINIMAX 200 Q GBT	715mm	1200mm	500mm	95kg	200ltr. (7cu.ft.)



MODEL	Description	Price	MODEL	Description	Price
MINIMAX 200 Q	Aluminium	£1536	MINIMAX 200 Q AMB	Aluminium	£877
MINIMAX 200 Q SS	Aluminium	£1579	MINIMAX 200 Q GBT	Aluminium	£2102
MINIMAX 200 Q HOT	Aluminium	£1352			

CATERING & RESTAURATEURS DISPLAY

Dominante/Gastro

Counter Top Displays

Features and Benefits

- * Electronically Controlled
- * Auto Defrost
- * Fan Assisted Cooling
- * Adjustable Shelving - Dominante Only, Gastro Fixed
- * Adjustable Feet
- * 2 Shelves as Standard
- * Fully Automatic Operation
- * Temperature Display
- * Sliding Glass Door
- * N.B. Shelves Not Designed for Bottles or Cans

Technical Specifications

Temperature Range +4/10°C /
+20/60°C For
Hot Plate

Refrigerant R134A

Type of Defrost Off Cycle

No. of Shelves 2

Exterior Finish White/
Grey (Gastro)

Interior Finish White Plastic

Power Required 13 Amp Supply



Gastro

Dominante 100G

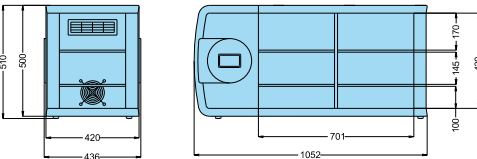

Dominante 100G Plus

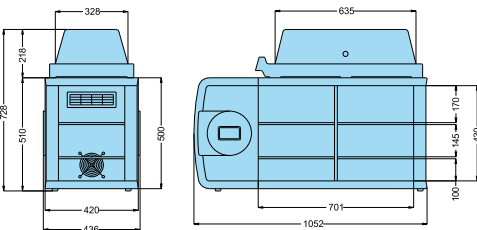

Dominante 100G



Plus Version With Integrated Hot Plate



Dimensions	Height:	Width:	Depth:	Weight:	Capacity:
External					
DOMINANTE 100G	510mm	1052mm	436mm	.42kg	100ltr. (3.5cu.ft.)
DOMINANTE 100G PLUS	728mm	1052mm	436mm	.45kg	100/25ltr. (3.5/0.88cu.ft.)
Internal					
DOMINANTE 100G	430mm	720mm	330mm		
DOMINANTE 100G PLUS	430mm	720mm	330mm		

MODEL	Description	Price	MODEL	Description	Price
DOMINANTE 100G	White	£896	GASTRO	Grey	£846
DOMINANTE 100G Plus	White	£1177			

Pacific Hot

Bain Marie Heated Display

Features and Benefits

- * Fully Automatic Operation
- * Interior Light
- * Digital Temperature Display
- * Rear Sliding Door for Serve Over
- * Front Sliding Door (up and over) for Self Service
- * Will accept Gastronorm Pans up to 2/1 Size
- * Gastronorm Pans Not Supplied - see Page ???
- * Cold Version Available - see Page 30

Technical Specifications

Temperature Range +30/+90°C

Exterior Finish Stainless Steel /Glass/Red

Interior Finish Stainless Steel /Glass

Power Required 13 Amp Supply



Pacific 680 Hot



Pacific 1000 Hot



Dimensions	Height:	Width:	Depth:	Capacity:
680	365mm	695mm	670mm	2 x 1/1 Pans
1000	365mm	1020mm	670mm	3 x 1/1 Pans

MODEL	Description	Price	MODEL	Description	Price
PACIFIC 680 HOT	Red / Glass	ORDER £928	PACIFIC 1000 HOT	Red / Glass	ORDER £1010

CATERING & RESTAURATEURS DISPLAY

Chef Range

Cold/Hot Counter Top Display Units

Features and Benefits

- * Adjustable Feet
- * 1 Shelf as Standard
- * Fully Automatic Operation
- * Interior Light
- * Digital Temperature Display
- * Will only accept 65mm deep Gastronorm Pans - Not supplied - see page 184

Technical Specifications

Temperature Range	+5/10°C
	+30/90°C (Hot)
Refrigerant	R404A
Type of Defrost	Off Cycle
No. of Shelves	1 per Unit
Exterior Finish	Stainless Steel
Interior Finish	Stainless Steel
Power Required	13 Amp Supply



Chef 2 Hot



Chef 3



Chef 2



Chef 3 Hot

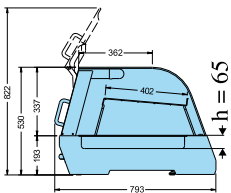

CHEF 1 HOT
Weight - 37kg

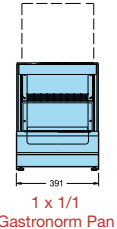

CHEF 2
Weight - 61.5kg

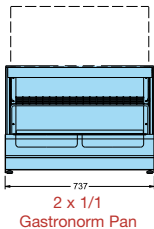

CHEF 3
Weight - 76.5kg

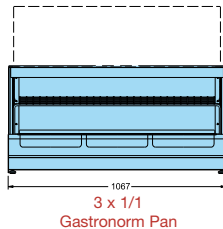

CHEF 4 HOT
Weight - 92kg

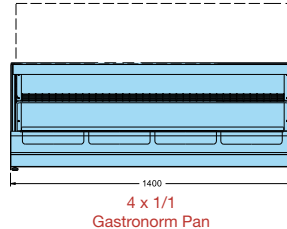

1 x 1/1
Gastronorm Pan

2 x 1/1
Gastronorm Pan

3 x 1/1
Gastronorm Pan

4 x 1/1
Gastronorm Pan

MODEL	Description	Price	MODEL	Description	Price
CHEF 1 HOT	Stainless Steel	£1312	CHEF 2 COLD	Stainless Steel	£1689
CHEF 2 HOT	Stainless Steel	£1499	CHEF 3 COLD	Stainless Steel	£1899
CHEF 3 HOT	Stainless Steel	£1689			
CHEF 4 HOT	Stainless Steel	£1879			

VARC Range

Refrigerated Topping Shelf

Features and Benefits

- * Clear Display
- * Front Glass hinges for cleaning
- * Pans Supplied as Standard (35mm deep)
- * Rear Sliding Doors
- * Digital Temperature Display
- * Switchable Interior Light
- * Adjustable Temperature

Technical Specifications

Temperature Range . . . +2/+7°C
 Refrigerant R134A
 Type of Defrost Manual
 Exterior Finish Silver
 Interior Finish Stainless Steel
 Power Required 13 Amp Supply



Varc 4



Varc 6



Varc 6 (Rear)



Dimensions	Height:	Width:	Depth:	Display Area:
VARC 4	245mm	1085mm	396mm	4x 1/3 GN Pans 35mm Deep
VARC 6	245mm	1437mm	396mm	6x 1/3 GN Pans 35mm Deep
VARC 8	245mm	1789mm	396mm	8x 1/3 GN Pans 35mm Deep
VARC 10	245mm	2141mm	396mm	10x 1/3 GN Pans 35mm Deep

MODEL	Description	Price	MODEL	Description	Price
VARC 4	Stainless Effect	£801	VARC 8	Stainless Effect	£1070
VARC 6	Stainless Effect	£933	VARC 10	Stainless Effect	£1242

VDARC Range

Refrigerated Topping Shelf



VECG 1A

*VECG 1A not supplied with Gastronorm Pans

Features and Benefits

- * Clear Display
- * Front glass hinges for cleaning
- * Rear Sliding Doors
- * Digital Temperature Display
- * Suitable For Prepared Fish
- * Double Evaporator
- * Gastronorm Pans Not Supplied - See Page 184
- * VDARC Accepts 1/3 Size Gastronorm Pans up to 35mm Deep
- * VECG 1A Accepts 1/1 Size Gastronorm Pans up to 35mm Deep
- * Switchable Interior Light
- * Adjustable Temperature

Technical Specifications

Temperature Range	0/+7°C
Refrigerant	R134A
Type of Defrost	Manual
No. of Shelves	2
Exterior Finish	
VECG 1A	Silver
VDARC	Black
Interior Finish	Stainless Steel
Power Required	13 Amp Supply



Gastronorm pans available (P.O.A.)
See p184



Suitable for use with prepared fish and sushi

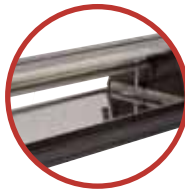

Unit can be used without Gastronorm Pans



Hinged Front Glass for easy cleaning



VDARC 6



Dimensions	Height:	Width:	Depth:	Display Area:
VDARC 6	250mm	1437mm	396mm	6x 1/3 GN Pans 35mm Deep
VDARC 8	250mm	1789mm	396mm	8x 1/3 GN Pans 35mm Deep
VECG 1A	470mm	1320mm	600mm	3x 1/1 GN Pans 65mm Deep

MODEL	Description	Price	MODEL	Description	Price
VDARC 6	Black	£1179	VECG 1A	Stainless Effect	£1561
VDARC 8	Black	£1314			

SC Range

Sliding Flat Glass Lid Chest Freezer

Features and Benefits

- * Flat Sliding Lids
- * Temperature Display
- * Defrost Drain Fitted
- * Inner Liner of Hammered Aluminium
- * Lock Fitted as Standard
- * Fitted Castors (Front 2 Lockable)
- * Adjustable Temperature

Technical Specifications

Temperature Range . . . -18/-22°C

Refrigerant R134A

Type of Defrost Manual

No. of Baskets Supplied

IC200SC 2

IC300SC 4

IC400SC 5

IC500SC 6

Exterior Finish White

Interior Finish Aluminium

Power Required 13 Amp Supply



Serveover canopy available (POA)



Full Set of Baskets



IC300SC

Dimensions	Height:	Width:	Depth:	Weight:	Capacity:
External					
IC200SC	860mm	730mm	640mm	36kg	165ltr. (5.8cu.ft.)
IC300SC	860mm	1020mm	640mm	55kg	255ltr. (9.0cu.ft.)
IC400SC	860mm	1310mm	640mm	63.5kg	350ltr. (12.3cu.ft.)
IC500SC	860mm	1560mm	640mm	64kg	430ltr. (15.2cu.ft.)
Internal					Max No. of Baskets
IC200SC	655mm	600mm	510mm		2
IC300SC	655mm	890mm	510mm		4
IC400SC	655mm	1180mm	510mm		5
IC500SC	655mm	1430mm	510mm		6

MODEL	Description	Price	MODEL	Description	Price
IC200SC	White	£446	IC400SC	White	£569
IC300SC	White	£531	IC500SC	White	£633

FROZEN DISPLAY

SCEB Range

Sliding Curved and Angled Lid
Chest Freezer

Features and Benefits

- * Curved Sliding Lid
- * Fitted Castors (Front 2 Lockable)
- * Fan Assisted Condenser
- * Temperature Display
- * Lock Fitted
- * Defrost drain fitted
- * Adjustable Temperature

Technical Specifications

Temperature Range . . . -18/-22°C

Refrigerant R134A

Type of Defrost Manual

No. of Baskets Supplied

IC200SCEB 2

IC300SCEB 4

IC400SCEB 5

IC500SCEB 6

Exterior Finish White

Interior Finish Aluminium

Power Required 13 Amp Supply



IC300SCEB

Dimensions	Height:	Width:	Depth:	Weight:	Capacity:
External					
IC200SCEB	925mm	720mm	620mm	49kg	165ltr. (5.8cu.ft.)
IC300SCEB	925mm	1020mm	620mm	57kg	255ltr. (9.0cu.ft.)
IC400SCEB	925mm	1310mm	620mm	66kg	350ltr. (12.3cu.ft.)
IC500SCEB	925mm	1560mm	620mm	72kg	430ltr. (15.2cu.ft.)
Internal					
Max No. of Baskets					
IC200SCEB	655mm	600mm	510mm	2	
IC300SCEB	655mm	890mm	510mm	4	
IC400SCEB	655mm	1180mm	510mm	5	
IC500SCEB	655mm	1430mm	510mm	6	

MODEL	Description	Price	MODEL	Description	Price
IC200SCEB	White	£517	IC400SCEB	White	£675
IC300SCEB	White	£618	IC500SCEB	White	£772

FROZEN DISPLAY

ACL Range

Sliding Glass Lid Freezer

Features and Benefits

- * Single Layer Glass Lids (Toughened)
- * Fan Assisted Condenser
- * Temperature Display
- * Optional Lid Lock Factory Option P.O.A
- * All Models Supplied with a Full Set of Baskets
- * Adjustable Temperature
- * Lockable Castors (Front 2 Only)

Technical Specifications

Temperature Range . . . -18/-22°C
Refrigerant R134A
Type of Defrost Manual
No. of Baskets Supplied
ACL320 4
ACL430 5
ACL550 6
Exterior Finish White
Interior Finish White
Power Required 13 Amp Supply



ACL320



ACL430

Full Set of Baskets



ACL550



Dimensions	Height:	Width:	Depth:	Weight:	Capacity:
External					
ACL320	890mm	1100mm	600mm	60kg	.290ltr. (10.24cu.ft.)
ACL430	890mm	1400mm	600mm	66kg	.392ltr. (13.84cu.ft.)
ACL550	890mm	1810mm	600mm	72kg	.527ltr. (18.6cu.ft.)
Internal					Max No of Baskets
ACL320	650mm	980mm	480mm		4
ACL430	650mm	1106mm	480mm		5
ACL550	650mm	1680mm	480mm		6

MODEL	Description	Price	MODEL	Description	Price
ACL320	White	£665	ACL550	White	£857
ACL430	White	£736			

FROZEN DISPLAY

VCL Range

Hinged Glass Lid Chest Freezer



Full Set of Baskets

VCL320



VCL550



VCL430

Features and Benefits

- * Single Layer Glass Lids (Toughened)
- * Fan Assisted Condenser
- * Temperature Display
- * All Models Supplied with a Full Set of Baskets
- * Adjustable Temperature
- * Lockable Castors (Front 2 Only)

Technical Specifications

Temperature Range . . . -18/-22°C

Refrigerant R134A

Type of Defrost Manual

No. of Baskets Supplied

VCL320 5

VCL430 6

VCL550 8

VCL700 7 Large Baskets

Exterior Finish White

Interior Finish White

Power Required 13 Amp Supply

Dimensions	Height: Front/Back:	Width:	Depth:	Weight:	Capacity:
External					
VCL320	730mm/890mm	1140mm	660mm	60kg	290ltr. (10.24cu.ft.)
VCL430	730mm/890mm	1440mm	660mm	66kg	392ltr. (13.84cu.ft.)
VCL550	730mm/890mm	1850mm	660mm	72kg	527ltr. (18.6cu.ft.)
VCL700	730mm/890mm	1950mm	760mm	84kg	671ltr. (23.7cu.ft.)
Internal					
VCL320	650mm/710mm	980mm	480mm	5	
VCL430	650mm/710mm	1280mm	480mm	6	
VCL550	650mm/710mm	1690mm	480mm	8	
VCL700	650mm/710mm	1790mm	580mm	7 Large	

MODEL	Description	Price	MODEL	Description	Price
VCL320	White	£710	VCL550	White	£948
VCL430	White	£796	VCL700	White	£1135

FROZEN DISPLAY

CSG Range

Sliding Flat Glass Lid Chest Freezer

Features and Benefits

- * Single Layer Glass Lids
- * Adjustable Temperature
- * Defrost Drain Fitted
- * Inner Liner of Hammered Aluminium
- * Lid Lock Factory Option
- * Castors Supplied (not fitted)

Technical Specifications

Temperature Range . . . -18/-22°C

Refrigerant R134A

Type of Defrost Manual

No. of Baskets Supplied

CSG22 1

CSG35/45/53/61/71 2

Exterior Finish White

Interior Finish Aluminium

Power Required 13 Amp Supply



CSG35

Dimensions	Height:	Width:	Depth:	Weight:	Capacity:
External					
CSG22	916mm . . .	724mm . . .	654mm . . .	44kg	217ltr. (7.7cu.ft.)
CSG35	916mm . . .	1054mm . . .	654mm . . .	54kg	350ltr. (12.4cu.ft.)
CSG45	916mm . . .	1304mm . . .	654mm . . .	64kg	450ltr. (15.9cu.ft.)
CSG53	916mm . . .	1504mm . . .	654mm . . .	67kg	530ltr. (18.7cu.ft.)
CSG61	916mm . . .	1704mm . . .	654mm . . .	77kg	611ltr. (21.6cu.ft.)
CSG71	903mm . . .	1804mm . . .	654mm . . .	81kg	705ltr. (24.9cu.ft.)

Dimensions	Height:	Width:	Depth:	Max No of Baskets
Internal				
CSG22	750mm . . .	606mm . . .	536mm . . .	2
CSG35	750mm . . .	936mm . . .	536mm . . .	3
CSG45	750mm . . .	1186mm . . .	536mm . . .	4
CSG53	750mm . . .	1386mm . . .	536mm . . .	4
CSG61	750mm . . .	1586mm . . .	536mm . . .	5
CSG71	740mm . . .	1686mm . . .	576mm . . .	6

MODEL	Description	Price	MODEL	Description	Price
CSG22	White	£689	CSG53	White	£951
CSG35	White	£755	CSG61	White	£1035
CSG45	White	£846	CSG71	White	£1094

CX Range

Sliding, Curved and Angled Lid Chest Freezer

Features and Benefits

- * Single Layer Curved Glass Lids
- * Concealed Thermostat Control
- * Defrost Drain Fitted
- * Lid Lock Option (Factory option)
- * Castors Supplied for Easy Movement (not fitted)
- * Coloured Top Options (Red and Blue)

Technical Specifications

Temperature Range . . . -18/-22°C

Refrigerant R134A

Type of Defrost Manual

No. of Baskets Supplied

CX22 1

CX35,45,61 2

Exterior Finish White

Interior Finish Aluminium

Power Required 13 Amp Supply



CX35

Dimensions	Height:	Width:	Depth:	Weight:	Capacity:
External					
CX22	919mm . . .	724mm . . .	680mm . . .	44kg	212ltr. (7.5cu.ft.)
CX35	919mm . . .	1054mm . . .	680mm . . .	54kg	341ltr. (12.1cu.ft.)
CX45	919mm . . .	1304mm . . .	680mm . . .	64kg	440ltr. (15.5cu.ft.)
CX61	919mm . . .	1704mm . . .	680mm . . .	77kg	594ltr. (21cu.ft.)

Dimensions	Height:	Width:	Depth:	Max No of Baskets
Internal				
CX22	750mm . . .	606mm . . .	536mm . . .	2
CX35	750mm . . .	936mm . . .	536mm . . .	4
CX45	750mm . . .	1186mm . . .	536mm . . .	5
CX61	750mm . . .	1586mm . . .	536mm . . .	7

MODEL	Description	Price	MODEL	Description	Price
CX22	White	£695	CX45	White	£857
CX35	White	£785	CX61	White	£1042

CVG Range

Hinged Glass Lid Chest Freezer



CVG53



Features and Benefits

- * Inner Liner of Hammered Aluminium
- * Defrost Drain Fitted
- * Optional Bumper Bar and Kick Strip (Standard on CVG53/61)
- * Fitted Castors
- * Adjustable Temperature

Technical Specifications

Temperature Range -18/-22°C
Refrigerant R134A
Type of Defrost Manual
No. of Baskets Supplied
 CVG22 1
 CVG35/45/53/61 2
Exterior Finish White
Interior Finish Aluminium
Power Required 13 Amp Supply

Dimensions	Height:	Width:	Depth:	Weight:	Capacity:
External					
CVG22	867mm . . .	724mm654mm	44kg.212ltr. (7.5cu.ft.)
CVG35	867mm . . .	1054mm654mm	54kg.342ltr. (12.1cu.ft.)
CVG45	867mm . . .	1304mm654mm	64kg.440ltr. (15.5cu.ft.)
CVG53	867mm . . .	1504mm654mm	67kg.519ltr. (18.4cu.ft.)
CVG61	867mm . . .	1704mm654mm	77kg.598ltr. (21.1cu.ft.)

Dimensions	Height:	Width:	Depth:	Max No of Baskets
Internal				
CVG22	735mm	606mm536mm . . .	2
CVG35	735mm	936mm536mm . . .	3
CVG45	735mm	1186mm536mm . . .	4
CVG53	735mm	1386mm536mm . . .	4
CVG61	735mm	1586mm536mm . . .	5

MODEL	Description	Price	MODEL	Description	Price
CVG22	White	£634	CVG53	White	£939
CVG35	White	£718	CVG61	White	£999
CVG45	White	£844			



CR180



CR 180

Sliding Curved Glass Lid Chest Freezer

Features and Benefits

- * Curved Sliding Glass Lids
- * Rollers Fitted
- * Low E Glass Lids
- * 70mm Polyurethane Insulation
- * Adjustable Temperature

Technical Specifications

Temperature Range -18/-25°C
Refrigerant R404A
Type of Defrost Manual
Exterior Finish White Steel
Interior Finish Galvanised
 Pre-painted
Power Required 13 Amp Supply

Dimensions	Height:	Width:	Depth:	Weight:	Capacity:
External					
CR 180	930mm . . .	780mm640mm . . .	61kg.175ltr. (6.1cu.ft.)
Internal					
CR 180	426mm . . .	640mm500mm		

MODEL	Description	Price
CR 180	White	£689

IF Range

Island Site Freezer

Features and Benefits

- * Anti Condensation Single Glazed Lids
- * Temperature Display
- * Bumper Bars as Standard
- * Baskets Optional
- * Fan Cooled Condenser
- * Adjustable Temperature

Technical Specifications

Temperature Range . . . -18/-22°C
 Refrigerant R404A
 Type of Defrost Manual
 Exterior Finish White
 Interior Finish White
 Power Required 13 Amp Supply



IF55



IF62



Illustration shows basket system layout

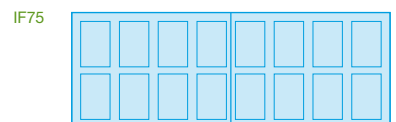
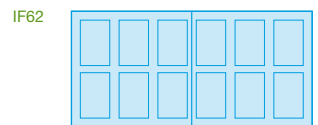
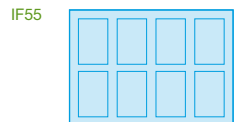

Dimensions	Height:	Width:	Depth:	Weight:	Capacity:
External					
IF55	785mm.	1545mm	960mm	91kg.595ltr. (21cu.ft.)
IF62	785mm.	2045mm	960mm	121kg.823ltr. (29cu.ft.)
IF75	785mm.	2545mm	960mm	139kg.	1.050ltr. (37cu.ft.)
Internal					
IF55	623mm.	1360mm	775mm	8	
IF62	623mm.	1860mm	775mm	12	
IF75	623mm.	2360mm	775mm	16	

**Max No of Baskets
Not Included**

MODEL	Description	Price	MODEL	Description	Price
IF55	White	£1064	IF75	White	£1498
IF62	White	£1319			

CHV Range

Island Site Freezer

Features and Benefits

- * Temperature Display
- * Bumper Bars
- * Easy Clean Interior
- * Single Glazed Lids
- * Adjustable Feet
- * Twin Controls on 1100CHV
- * Fan Cooled Condenser
- * 4FL Models Have 4 Lids Per Freezer
- * Castors (Factory Option)
- * 900 and 1100 have partition

Technical Specifications

Temperature Range . . . -18/-22°C
 Refrigerant R134A
 Type of Defrost Manual
 Exterior Finish White Anodised
 Interior Finish White
 Power Required 13 Amp Supply



750 CHV4FL



750 CHV



Basket System (Optional)



900 CHV4FL



900 CHV



1100 CHV4FL



1100 CHV



Picture shows control panel



Dimensions	Height:	Width:	Depth:	Weight:	Capacity:
External					
750 CHV/4FL	780mm	1550mm	960mm	85kg	563ltr. (20cu.ft.)
900 CHV/4FL	780mm	2050mm	960mm	105kg	859ltr. (30cu.ft.)
1100 CHV/4FL	780mm	2505mm	960mm	126kg	1025ltr. (36cu.ft.)
Internal					
750 CHV/4FL	575mm	1375mm	790mm	3	8
900 CHV/4FL	575mm	1880mm	790mm	5	12
1100 CHV/4FL	575mm	2x1140mm	790mm	7	16

Max No of Baskets Not Included
 CHV / 4FL

MODEL	Description	Price	MODEL	Description	Price
750 CHV	White Anodised steel	£985	750 CHV4FL	White Anodised steel	£1045
900 CHV	White Anodised steel	£1149	900 CHV4FL	White Anodised steel	£1209
1100 CHV	White Anodised steel	£1372	1100 CHV4FL	White Anodised steel	£1419

FROZEN DISPLAY

Vision Range

High Vision Freezer



Multiplexed run to create complete shop around freezer island

Multiplexing Kit
VISION 150 Kit £80
VISION 200 Kit £92



VISION 180 HC

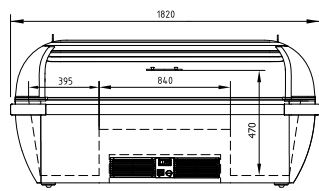

VISION 180 HC

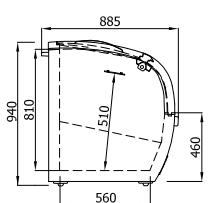
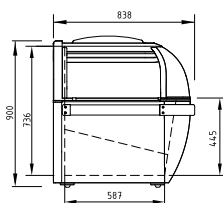

VISION 150 / 200

FROZEN DISPLAY

Vision Range

High Vision Freezer

Features and Benefits

- * Temperature Display
- * Bumper Bars as Standard
- * Hinged or Sliding Options
- * Interior Lighting
- * Dividers as Standard
- * Fan Cooled Condenser
- * Adjustable Temperature

Technical Specifications

No. of Dividers

Supplied (Large Small)
Vision 150 3 (2 1)

Vision 200 4 (3 1)

Vision 180HC 2 (2 0)

Temperature Range. -18/-22°C

Refrigerant R134A

Type of Defrost Manual

Exterior Finish White

Interior Finish White

Power Required 13 Amp Supply



VISION 150 H



VISION 200 S



Slide Out Condensing Unit for Easy Servicing



Single Shelf
 150 - £150
 200 - £171
 180 HC - £162

Double Shelf
 150 - £265
 200 - £325
 180 HC - £286

Shelving only suitable for use with sliding lid freezers.

Dimensions	Height:	Width:	Depth:	Weight:	Capacity:
External					
VISION 150 H	940mm	1500mm	880mm	115kg350ltr. (12.3cu.ft.)
VISION 200 H	940mm	2000mm	880mm	140kg518ltr. (18.3cu.ft.)
VISION 150 S	900mm	1500mm	840mm	113kg350ltr. (12.3cu.ft.)
VISION 200 S	900mm	2000mm	840mm	138kg518ltr. (18.3cu.ft.)
VISION 180 HC	900mm	1820mm	840mm	125kg518ltr. (18.3cu.ft.)
Internal					
VISION 150 H	790/430mm	1360mm	560mm		
VISION 200 H	790/430mm	1860mm	560mm		
VISION 150 S	790/430mm	1360mm	560mm		
VISION 200 S	790/430mm	1860mm	560mm		
VISION 180 HC	736/445mm	1630mm	560mm		

MODEL	Description	Price	MODEL	Description	Price
VISION 150 H	White	£1432	VISION 150 S	White	£1409
VISION 200 H	White	£1789	VISION 200 S	White	£1744
			VISION 180 HC	White	£2065

FROZEN DISPLAY

UF Range

Glass Door Display Freezers



Features and Benefits

- * Adjustable Temperature
- * Interior Light
- * Adjustable Shelving
- * Replaceable Door Gaskets
- * Aluminium Interior
- * Triple Glazed Door

Technical Specifications

Temperature Range . . . -14°C/-18°C
Refrigerant R134A
Type of Defrost Manual
No. of Shelves
UF50G 2
UF100G 3
Exterior Finish White
Interior Finish Aluminium
Power Required 13 Amp Supply



UF100G

Dimensions	Height:	Width:	Depth:	Capacity:	Weight:
External					
UF50G	535mm	570mm	530mm	34kg	50ltr. (1.76cu.ft.)
UF100G	680mm	610mm	545mm	45kg	100ltr. (3.53cu.ft.)
Internal					
UF50G	380mm	450mm	425mm		
UF100G	530mm	490mm	435mm		

MODEL	Description	Price	MODEL	Description	Price
UF50G	White	£448	UF100G	White	£599

LGF4

Glass Door Display Freezers

Features and Benefits

- * Adjustable Temperature
- * Switchable Interior Light
- * Heated Door to Eliminate Condensation
- * Static Fixed Shelves
- * Fan Assisted Cooling

Technical Specifications

Temperature Range . . . -18°C/-22°C
Refrigerant R134A
Type of Defrost Manual
No. of Shelves 2 Fixed
Exterior Finish White
Interior Finish White
Power Required 13 Amp Supply



LGF4

Dimensions	Height:	Width:	Depth:	Weight:	Capacity:
External					
LGF4	896mm	550mm	622mm	64kg	118ltr. (4.1cu.ft.)
Internal					
LGF4	758mm	430mm	400mm		

MODEL	Description	Price
LGF4	White	£899

FROZEN DISPLAY

UFG1380

Glass Door Display Freezers



UFG1380



Features and Benefits

- * Fan Assisted Cooling
- * Switchable Interior Light
- * Digital Temperature Display
- * Adjustable Temperature
- * Drain Hole for Defrosting
- * Lock
- * Chiller Option see Page 19
- * Solid Door Option see Page 155
- * Door is Not Reversible

Technical Specifications

Temperature Range -18/-22°C
Refrigerant R134A
Type of Defrost Manual
No. of Shelves 6 Fixed Static
Exterior Finish White with aluminium door frame
Interior Finish White
Power Required 13 Amp Supply

Dimensions	Height:	Width:	Depth:	Capacity:	Weight:
External					
UFG1380	1825mm	595mm	600mm	97kg	372ltr. (13cu.ft.)
Internal Dimensions					
UFG1380	1541mm	448mm	445mm		

MODEL	Description	Price
UFG1380	White	£997

Expo Range

Glass Door Display Freezers

Features and Benefits

- * Fully Automatic Operation (360 NST Manual)
- * Electronically Controlled
- * Switchable Interior Light
- * Switchable Illuminated Canopy
- * Temperature Display
- * Fan Assisted Cooling (360 NST Static)
- * Adjustable Shelving
- * Static Fixed Shelves (360 NST)
- * Triple Glazed Doors
- * Reversible Door (Factory Option) (360 NST, 430 NV)
- * Matching Chiller p24

Technical Specifications

Temperature Range . . . -15/-28°C

Refrigerant R507

Type of Defrost Electric

No. of Shelves 5/6 Fixed

360NST

Exterior Finish White

Interior Finish White

Power Required 13 Amp Supply



Expo 360 NST



Expo 430 NV



Dimensions	Height:	Width:	Depth:	Weight:	Capacity:
External					
EXPO 360 NST	1980mm	670mm	642mm	125kg	402ltr. (14.2cu.ft.)
EXPO 430 NV	1980mm	670mm	672mm	123kg	402ltr. (14.2cu.ft.)
Internal					
EXPO 360 NST	1525mm	548mm	461mm		
EXPO 430 NV	1525mm	548mm	491mm		

MODEL	Description	Price	MODEL	Description	Price
EXPO 360 NST	White	£1296	EXPO 430 NV	White	£1698

Expo Range

Glass Door Display Freezers

Features and Benefits

- * Fully Automatic Operation
- * Electronically Controlled
- * Switchable Interior Light
- * Temperature Display
- * Fan Assisted Cooling
- * Switchable Illuminated Canopy
- * Adjustable Shelving
- * Triple Glazed Doors
- * Reversible Door 500NV (Factory Option)
- * Matching Chiller p24

Technical Specifications

Temperature Range . . . -15/-28°C
 Refrigerant R507
 Type of Defrost Electric
 No. of Shelves 5
 Exterior Finish White
 Interior Finish White
 Power Required 13 Amp Supply



Expo 1100NV



Expo 500 NV

Dimensions	Height:	Width:	Depth:	Weight:	Capacity:
External					
EXPO500NV	1980mm	670mm	752mm	135kg	472ltr. (16.7cu.ft.)
EXPO1100NV	1980mm	1340mm	736mm	263kg	1047ltr. (36.9.1cu.ft.)
Internal					
EXPO500NV	1525mm	548mm	571mm		
EXPO1100NV	1525mm	1221mm	571mm		

MODEL	Description	Price	MODEL	Description	Price
EXPO500NV	White	£1816	EXPO1100NV	White	£3549

FROZEN DISPLAY

EIS Range

Glass Door Display Freezers

Features and Benefits

- * Fan Assisted Cooling
- * Auto Defrost
- * Fully Automatic Operation
- * Fully Adjustable Shelving
- * Electronically Controlled
- * Adjustable Temperature
- * Chiller Option - See Page 22
- * EIS110 has 2 Separate Compartments with Dual Temperature Controls

Technical Specifications

Temperature Range . . . -18/-25°C
Refrigerant R404A
Type of Defrost Electric
No. of Shelves 4
Exterior Finish White
Interior Finish White
Power Required 13 Amp Supply



EIS45



EIS110



Dimensions	Height:	Width:	Depth:	Weight:	Capacity:
External					
EIS45	1955mm.	670mm.	665mm	138kg.379ltr. (13.4cu.ft.)
EIS110	1977mm.	1340mm	732mm	276kg.964ltr. (34cu.ft.)
Internal					
EIS45	1500mm.	550mm.	420mm		
EIS110	1300mm.	2x 550mm.	471mm		

MODEL	Description	Price	MODEL	Description	Price
EIS45	White	£1609	EIS110	White	£3646

CAF1300G

Glass Door Display Freezers



CAF1300WG



CAF1300SG



Features and Benefits

- * Fully Automatic Fan Assisted
- * Suitable for High Ambient (42°C)
- * Adjustable Shelving
- * Switchable Interior Light
- * Stainless Steel Interior
- * White or Stainless Exterior Options
- * Temperature Display
- * Top Mounted Refrigeration Unit
- * Lock
- * Chiller Option see Page 25
- * Electronic Controller
- * Lockable Castors

Technical Specifications

Temperature Range -18/-22°C
Refrigerant R404A
Type of Defrost Electric
No. of Shelves 5 per side
Exterior Finish White or
 Stainless Steel
Interior Finish Stainless Steel
Power Required 13 Amp Supply

Dimensions	Height:	Width:	Depth:	Weight:	Capacity:
External					
CAF1300	2000mm	1420mm	800mm	255kg	1300ltr. (45.9cu.ft.)
Internal					
CAF1300	1480mm	1300mm	680mm		

MODEL	Description	Price	MODEL	Description	Price
CAF1300WG	White Glass Door	£3292	CAF1300SG	Stainless Glass Door	£3799



WIGHT 200

Wight Range

Open Top Island Site Freezer

Features and Benefits

- * Electric Defrost
- * Fully Automatic Operation
- * Twin Compressors
- * Night Covers Included
- * Temperature Display
- * Big Capacity in Small Floor Area
- * Easy Clean Interior
- * Adjustable Temperature

Technical Specifications

Temperature Range -20°C
Refrigerant R404A
Type of Defrost Electric
Exterior Finish White
Interior Finish White
Power Required 13 Amp Supply

Dimensions	Height:	Width:	Depth:	Weight:	Capacity:
External					
WIGHT 150	897mm	1542mm	1042mm	152kg	671ltr. (23.6cu.ft.)
WIGHT 200	897mm	2042mm	1042mm	197kg	914ltr. (32.1cu.ft.)
WIGHT 250	897mm	2542mm	1042mm	218kg	1158ltr. (40.8cu.ft.)
Internal					
WIGHT 150	553mm	1380mm	880mm		
WIGHT 200	553mm	1880mm	880mm		
WIGHT 250	553mm	2330mm	880mm		

MODEL	Description	Price	MODEL	Description	Price
WIGHT 150	White	£1889	WIGHT 250	White	£2577
WIGHT 200	White	£2244			

FROZEN DISPLAY

Calipso

Open Top Island Site Freezer

Features and Benefits

- * Electric Defrost
- * Fully Automatic Operation
- * Temperature Display
- * Open Top
- * Adjustable Temperature

Technical Specifications

Temperature Range . . . -20°C
Refrigerant R507
Type of Defrost Electric
Exterior Finish White
Interior Finish White
Power Required 13 Amp Supply



Calipso 200

Dimensions	Height:	Width:	Depth:	Weight:	Capacity:
External					
CALIPSO 150	865mm	1550mm	1050mm	110kg646ltr. (22.8cu.ft.)
CALIPSO 200	865mm	2050mm	1050mm	151kg881ltr. (31.1cu.ft.)
CALIPSO 250	865mm	2550mm	1050mm	192kg	1.115ltr. (39.3cu.ft.)
Internal					
CALIPSO 150	310mm	1380mm	862mm		
CALIPSO 200	310mm	1880mm	862mm		
CALIPSO 250	310mm	2380mm	862mm		

MODEL	Description	Price	MODEL	Description	Price
CALIPSO 150	White	£1997	CALIPSO 250	White	£2659
CALIPSO 200	White	£2348			

Samba Combi

Wall Site Combi Freezer

Features and Benefits

- * Fully Automatic Operation
- * Electronically Controlled
- * Interior Light
- * Digital Temperature Display
- * Fan Assisted Cooling
- * Self Closing Doors
- * Illuminated Canopy
- * Easily Replaceable Door Gasket/s
- * Optional Chiller Top Section (No doors as standard)

Technical Specifications

Temperature Range . . . -20/-22°C
 +2/+4°C
Refrigerant R507
Type of Defrost Electric
No. of Shelves
Samba 125 4 Freezer
Samba 180 6 Freezer
Exterior Finish White
Interior Finish White
Power Required 20 Amp Supply



Sam 180 AP

Sam 125 AN



Dimensions	Height:	Width:	Depth:	Weight:	Capacity:
External					
SAM125 AN	2004mm	1242mm	916mm	215kg246-305ltr. (8.7-10.7cu.ft.)
SAM180 AN	2004mm	1822mm	916mm	317kg375-463ltr. (13.2-16.3cu.ft.)
SAM125 AP	2004mm	1242mm	916mm	205kg296-246ltr. (8.1-10.4cu.ft.)
SAM180 AP	2004mm	1822mm	916mm	310kg375-450ltr. (13.2-15.8cu.ft.)

MODEL	Description	Price	MODEL	Description	Price
SAM125AP	White (Chiller/Freezer)	£4017	SAM125AN	White (Freezer/Freezer)	£4139
SAM180AP	White (Chiller/Freezer)	£5048	SAM180AN	White (Freezer/Freezer)	£5170

FROZEN DISPLAY



Gaya Top Range

Wall Site Freezer



GAYA TOP 13

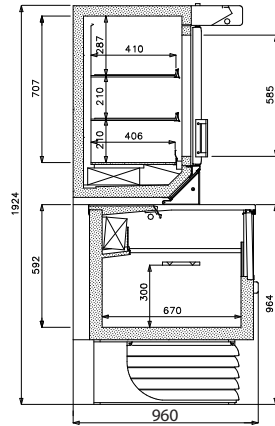

Features and Benefits

- * Auto Defrost
- * Door Heaters for Demisting
- * 2 Hinged Doors - Top 13
- * 3 Hinged Doors - Top 20
- * Fan Assisted Cooling
- * Fully Automatic Operation
- * Switchable Interior Light
- * Electronically Controlled
- * Adjustable Shelving
- * Adjustable Temperature

Technical Specifications

Temperature Range . . . -18/-20°C

Refrigerant R404A

Type of Defrost Electric

No. of Shelves

Top 13 4

Top 20 6

Exterior Finish White/Cream

Interior Finish White

Power Required 20 Amp Supply



GAYA TOP 20



Dimensions	Height:	Width:	Depth:	Weight:	Capacity:
External					
GAYA TOP 13	1972mm	1374mm	920mm	280kg	300-340ltr. (10.6-12cu.ft.)
GAYA TOP 20	1972mm	2006mm	920mm	410kg	450-510ltr. (15.8-18cu.ft.)

MODEL	Description	Price	MODEL	Description	Price
GAYA TOP 13	White	£4368	GAYA TOP 20	White	£5256

FROZEN DISPLAY

UDD7

Scoop Ice Cream Display

Features and Benefits

- * Accepts 7 x 5ltr napoli pans (not supplied)
- * Storage Under Pans
- * Sliding Glass Lids
- * Adjustable Temperature
- * Curved Glass Display
- * Castors Fitted

Technical Specifications

Temperature Range . . . -18/-22°C
 Type of Defrost Manual
 No. of Pans 7 x 5ltr
 Display
 Exterior Finish White
 Interior Finish Hammered Aluminium
 Power Required 13 Amp Supply



Only 516mm deep



UDD7

Dimensions	Height:	Width:	Depth:	Weight:	Capacity:
External					
UDD7	1264mm	1327mm	516mm	95kg347ltr. (12.25cu.ft.)
Internal					
UDD7	765mm (max.)	1206mm	395mm		

MODEL	Description	Price
UDD7	White	£1024

Slant 510

Scoop Ice Cream Display

Features and Benefits

- * Interior Light
- * Accepts 5 Litre Napoli Pans (Not Supplied)
- * High Storage Capacity
- * Sliding Glass Lids
- * Understorage

Technical Specifications

Temperature Range . . . -18°C
 Refrigerant R507
 Type of Defrost Manual
 No. of Bins on Display
 Slant 510 9
 Exterior Finish White
 Interior Finish White
 Power Required 13 Amp Supply



SLANT 510

Dimensions	Height:	Width:	Depth:	Capacity:
External				
SLANT 510	1235mm	1341mm	687mm	9x5ltr. Pans
Internal				Max No. of Pans in under storage
SLANT 510	630mm	1217mm	563mm	6

MODEL	Description	Price
SLANT 510LUX	White	£1171

Top 6E & 7E

Scoop Ice Cream Display



Top 6E

Top 7E



Features and Benefits

- * Fully Automatic Operation
- * Electronically Controlled
- * Interior Light
- * Accepts 5 Litre Napoli Pans (Not Supplied)
- * High Storage Capacity Understorage)
- * Fitted Castors
- * Optional Scoop Wash (Needs Water & Waste Connection) POA
- * Adjustable Temperature

Technical Specifications

Temperature Range . . . -18°C
 Refrigerant R507
 Type of Defrost Electric
 No. of Bins on Display
 TOP 6E 6
 TOP 7E 7
 Exterior Finish White
 Interior Finish Painted Steel
 Power Required 13 Amp Supply

Dimensions	Height:	Width:	Depth:	Weight:	Capacity:
External					
TOP 6E	1175mm	1217mm	700mm	95kg	96ltr. (3.4cu.ft.)
TOP 7E	1175mm	1363mm	700mm	99kg	121ltr. (4.3cu.ft.)
Internal Dimensions					
TOP 6E	744mm	1067mm	498mm	8	
TOP 7E	744mm	1217mm	498mm	12	
Height from back to rear shelf - 914mm					

MODEL	Description	Price	MODEL	Description	Price
TOP 6E	White	£1367	TOP 7E	White	£1436

J Range

Scoop Ice Cream Display



J7E



Features and Benefits

- * Fully Automatic Operation
- * Electronically Controlled
- * Accepts 5 Litre Napoli Pans (Not Supplied)
- * High Storage Capacity (Double Layer & Understorage)
- * Fitted Castors for Easy Movement
- * Interior Light
- * Adjustable Temperature

Technical Specifications

Temperature Range . . . -18°C
 Refrigerant R507
 Type of Defrost Electric
 No. of Bins on Display
 J7E 7
 J9E 9
 Maximum No. of Pans in Under Storage
 J7E 12+7
 J9E 16+9
 Exterior Finish White
 Interior Finish Coated Steel
 Power Required 13 Amp Supply

Dimensions	Height:	Width:	Depth:	Weight:	Capacity:
External					
J7E	1224mm	1341mm	723mm	117kg	7+7 5ltr. Pans
J9E	1224mm	1656mm	723mm	150kg	9+9 5ltr. Pans

MODEL	Description	Price	MODEL	Description	Price
J7E	White	£1857	J9E	White	£2251

ICE CREAM DISPLAY

Fenice

Scoop Ice Cream Display

Features and Benefits

- * Fully Automatic Operation
- * Electronically Controlled
- * Interior Light
- * Accepts 5 Litre Napoli Pans (Not Supplied)
- * High Storage Capacity (Understorage)
- * Fitted Castors
- * Scoop Wash Needs Water & Waste Connection (optional part)
- * Adjustable Temperature

Technical Specifications

Temperature Range . . . -18°C
 Refrigerant R507
 Type of Defrost Electric
 No of Bins on Display
 FENICE 80 4
 FENICE 103 6
 FENICE 118 7
 Exterior Finish White
 Interior Finish White
 Power Required 13 Amp Supply



FENICE 118



Dimensions	Height:	Width:	Depth:	Weight:	Capacity:
External					
FENICE 80	1165mm	830mm	702mm	82kg	4x 5ltr. Pans
FENICE 103	1165mm	1164mm	702mm	120kg	6x 5ltr. Pans
FENICE 118	1165mm	1314mm	702mm	136kg	7x 5ltr. Pans

MODEL	Description	Price	MODEL	Description	Price
FENICE 80	White	£1568	FENICE 118	White	£1976
FENICE 103	White	£1846			

Edera

Scoop Ice Cream Display

Features and Benefits

- * Fully Automatic Operation
- * Electronically Controlled
- * Accepts 5 Litre Napoli Pans (Not Supplied)
- * High Storage Capacity (Understorage)
- * Fitted Castors

Technical Specifications

Temperature Range . . . -18°C
 Refrigerant R507
 Type of Defrost Electric
 No. of Bins on Display
 Edera 126 10
 Edera 157 13
 Maximum No. of Pans in Under Storage
 Edera 126 10
 Edera 157 16
 Exterior Finish White
 Interior Finish Coated Steel
 Power Required 13 Amp Supply



EDERA 126

EDERA 157



Dimensions	Height:	Width:	Depth:	Weight:	Capacity:
External					
EDERA 126	1274mm	1420mm	860mm	170kg	10x 5ltr. Pans
EDERA 157	1274mm	1770mm	860mm	235kg	13x 5ltr. Pans

MODEL	Description	Price	MODEL	Description	Price
EDERA 126	White	£3159	EDERA 157	White	£3298

Ice 2V

Counter Top Ice Cream Scoop

Features and Benefits

- * Manual Defrost
- * Hinged Lid
- * Accepts 2 x 5ltr napoli pans (not supplied)
- * Adjustable Temperature

Technical Specifications

Temperature Range . . . -10/-20°C
 Refrigerant R404A
 Type of Defrost Manual
 Exterior Finish White
 Interior Finish White
 Power Required 13 Amp Supply



ICE 2V

Dimensions	Height:	Width:	Depth:	Weight:	Capacity:
External					
ICE 2V	385mm	470mm	700mm	28kg2x5ltr.
Internal					Max No. of Pans
ICE 2V	170mm	370mm	390mm		2

MODEL	Description	Price
ICE 2V	White	£668

Bi-Ice

Split Level Display Freezer

Features and Benefits

- * Dual Layer
- * Sliding Lid
- * Curved Front for better Display
- * Switchable Lights (Both Levels)
- * Adjustable Temperature (Separate for Top & Bottom Levels)
- * 8 Dividers Supplied (4 per Level)
- * Rollers Fitted to Base

Technical Specifications

Temperature Range . . . -18/-22°C
 Refrigerant R404A
 Type of Defrost Manual
No. of Dividers
 BI-ICE Mini 4
 BI-ICE 8
 Exterior Finish White/Grey
 Interior Finish Hammered Aluminium
 Power Required 13 Amp Supply



BI-ICE



BI-ICE MINI
Branded Version

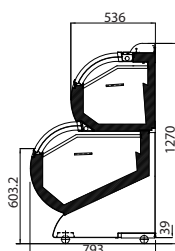

Dimensions	Height:	Width:	Depth:	Weight:	Capacity:
External					
BI-ICE Mini	1270mm	808mm	793mm	112kg264ltr. (9.32cu.ft.)
BI-ICE	1270mm	1258mm	793mm	122kg440ltr. (15.5cu.ft.)

MODEL	Description	Price	MODEL	Description	Price
BI-ICE Mini	White	ORDER £2138	BI-ICE	White	ORDER £2355

ICE CREAM DISPLAY

Carisma

Forced Air Scoop Ice Cream Display

Features and Benefits

- * Hinged Tiltable Curved Front Glass for easy cleaning
- * Fully Automatic Operation
- * Electronically Controlled
- * Interior Light
- * Accepts 4 or 5 Litre Napoli Pans (Not Supplied)
- * Stainless Steel Interior
- * Optional Scoop Wash Needs Water and Waste Connections
- * Fan Assisted Cooling
- * Castors Optional Extra

Technical Specifications

Temperature Range -15/-18°C

Refrigerant R404A

Type of Defrost Auto

No of Bins on Display

Carisma 4 8x4 ltr or
6x5 ltr Pans

Carisma 6 12x4 ltr or
8x5 ltr Pans

Carisma 7 14x4 ltr or
10x5 ltr Pans

Exterior Finish White/Green

Interior Finish Stainless Steel

Power Required 13 Amp Supply

Carisma 4 85kg

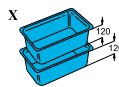
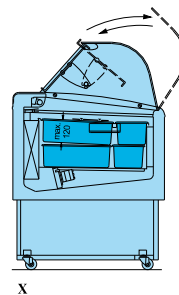
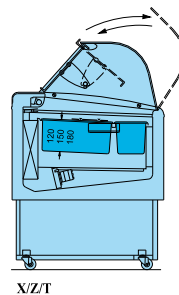
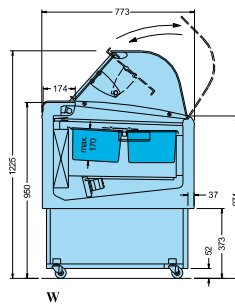
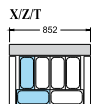
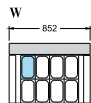

Carisma 6+6 115kg

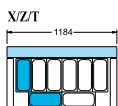
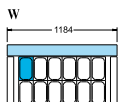

Carisma 7+7 132kg

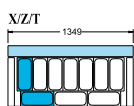
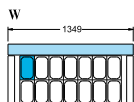

Carisma 4



Carisma 6



Carisma 7



Castors Optional Extra

MODEL	Description	Price	MODEL	Description	Price
CARISMA 4	White/Green	ORDER £3626	CARISMA 7	White/Green	ORDER £3961
CARISMA 6	White/Green	ORDER £3765			

Gran Gala

Forced Air Scoop Ice Cream Display

Features and Benefits

- * Interior Light
- * Accepts 5 Litre Napoli Pans (Not Supplied)
- * Fan Assisted Cooling
- * Anti Fogging System for Front Curved Glass (Fan Assist)
- * Stainless Steel Interior
- * Rear Night Blind
- * Electrically Controlled
- * Digital Temperature Display
- * Fully Automatic Operation
- * Polished S/Steel Rear Shelf and Back
- * Castors Optional Extra
- * Scoop Wash Optional Extra

Technical Specifications

Temperature Range . . . -15/-18°C

Refrigerant R404A

Type of Defrost Auto

No. of Bins on Display

Gran Gala 12 12 x 5 Litre

Gran Gala 16 16 x 5 Litre

Gran Gala 18 18 x 5 Litre

Gran Gala 20 20 x 5 Litre

Gran Gala 24 24 x 5 Litre

Exterior Finish Blue/Red/Green

Interior Finish White S/Steel

Power Required 20 Amp Supply
except
Gran Gala 24
3 Phase



Blue



Green



Night Blind in use



Fitted Castors £135



Scoop Wash £152

Gran Gala 12 - 260kg
X/Z/T

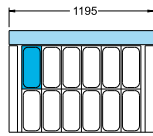

Gran Gala 16 - 315kg
X/Z/T

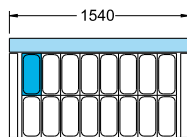

Gran Gala 18 - 340kg
X/Z/T

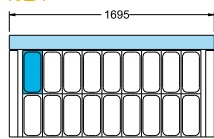

Gran Gala 20 - 370kg
X/Z/T

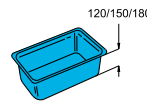
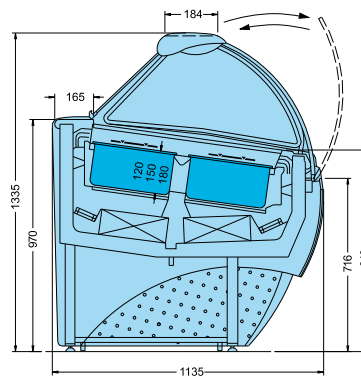
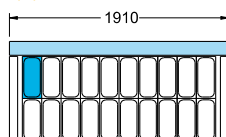

Gran Gala 24 - 450kg
X/Z/T

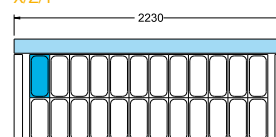

Gran Gala 18 Orange



ICE CREAM DISPLAY

MODEL	Description	Price	MODEL	Description	Price
GRAN GALA 12	Blue/Orange/Green	£9067	GRAN GALA 18	Blue/Orange/Green	£11209
GRAN GALA 16	Blue/Orange/Green	£11002	GRAN GALA 20	Blue/Orange/Green	£11992
			GRAN GALA 24	Blue/Orange/Green	£13070

UR Range

Undercounter Refrigerator

Features and Benefits

- * Fan Assisted Cooling
- * Fully Automatic
- * Lock Fitted
- * Digital Temperature Display
- * Adjustable Shelves
- * Stainless Steel or White Exterior
- * Freezer Option - See Page 152
- * Adjustable Feet
- * Reversible Door P.O.A.

Technical Specifications

Temperature Range . . . +2/+4°C
Refrigerant R134A
Type of Defrost Off Cycle
No. of Shelves 3
Exterior Finish White or
 Stainless Steel
Interior Finish White
Power Required 13 Amp Supply



UR150 White



UR150 SS Stainless



Dimensions	Height:	Width:	Depth:	Weight:	Capacity:
External					
UR150	820mm	600mm	600mm	38kg	146ltr. (5.15cu.ft.)
UR150 SS	820mm	600mm	600mm	41kg	146ltr. (5.15cu.ft.)
Internal					
UR150	685mm	515mm	415mm		
UR150 SS	685mm	515mm	415mm		

MODEL	Description	Price	MODEL	Description	Price
UR150	White	£459	UR150 SS	Stainless Steel	£548

CHILLED STORAGE

Libra Range

Undercounter Refrigerators

Features and Benefits

- * Fully Automatic Operation
- * Replaceable Door Gasket
- * Lock Fitted
- * Digital Temperature Display
- * Fan Assisted Cooling
- * Adjustable Shelving
- * Adjustable Feet
- * Stainless Steel or White Exterior
- * Freezer Option - See Page 153/154
- * Reversible Door P.O.A.

Technical Specifications

Temperature Range . . . 0/+5°C
 Refrigerant R134A
 Type of Defrost Off Cycle
 No. of Shelves 2
 Exterior Finish White or
 Stainless Steel
 Interior Finish White
 Power Required 13 Amp Supply



CAR 175W



CAR 175G



CAR 175S



Dimensions	Height:	Width:	Depth:	Weight:	Capacity:
External					
CAR 175	850mm	592mm	650mm	55kg	155ltr. (5.5cu.ft.)
Internal					
CAR 175	725mm	518mm	440mm		

MODEL	Description	Price	MODEL	Description	Price
CAR175W	White	£524	CAR175G	White/Glass Door	£599
CAR175S	Stainless Steel	£598	CAR175SG	S/Steel/Glass Door	£668

X3

Fresh Fish Refrigerator

Features and Benefits

- * Low Speed Fan for Consistent Cooling
- * Corrosion Free Refrigeration System
- * Electronically Controlled
- * Digital Temperature Display
- * Replaceable Door Gasket
- * Drain for Easy Cleaning
- * 5 Strong Removeable Drawers with Stainless Steel Risers
- * Holds 10-12 Stone of Fresh Fish
- * Adjustable Temperature
- * Adjustable Feet

Technical Specifications

Temperature Range . . . -2/0°C
Refrigerant R404A
Type of Defrost Timed Off Cycle
No. of Shelves 5 Drawers with Risers
Exterior Finish Stainless Steel
Interior Finish Stainless Steel
Power Required 13 Amp Supply



X3



Dimensions	Height:	Width:	Depth:	Weight:	Capacity:
External					
X3	1885mm.	600mm	600mm	106kg620ltr. (21.8cu.ft.)
Internal					
X3	1340mm.	500mm	460mm		
Tray.	105mm.	325mm	420mm		
<small>(Internal height without riser 135mm)</small>					

• This Cabinet must be used in conjunction with crushed ice

MODEL	Description	Price
X3	Stainless Steel	£1385

SD1380

Solid Door Refrigerator



Features and Benefits

- * Auto Defrost
- * Fan Assisted Cooling
- * Lock Fitted
- * Fully Automatic Operation
- * Adjustable Shelving
- * Reversible Door (Factory option)
- * Adjustable Feet
- * Temperature Display
- * Freezer Option - See Page 155
- * Glass door available Page 19

Technical Specifications

Temperature Range +1/+12°C
Refrigerant R134A
Type of Defrost Off Cycle
No. of Shelves 7
Exterior Finish White
Interior Finish White
Power Required 13 Amp Supply



Dimensions	Height:	Width:	Depth:	Weight:	Capacity:
External					
SD1380	1825mm.	595mm	640mm	115kg.372ltr. (13cu.ft.)
Internal					
SD1380	1550mm.	515mm	470mm		

MODEL	Description	Price
SD 1380	White	£639

A400 Range

Solid Door Refrigerator

Features and Benefits

- * Fan Assisted Cooling
- * Temp Range -2/+4°C
- * Auto Defrost
- * Fully Automatic Operation
- * Replaceable Door Gasket
- * Analogue Temperature Display
- * Lock Fitted
- * Reversible Door (Factory Option)
- * Option of White (PV) or Stainless Steel (PVS)
- * Freezer Option - See Page 156
- * Optional Castor Base (POA)
- * Adjustable Temperature

Technical Specifications

Temperature Range . . . -2/+4°C

Refrigerant R134A

Type of Defrost Hot Gas

No. of Shelves 4

Exterior Finish White or
Stainless Steel

Interior Finish White Steel

Power Required 13 Amp Supply

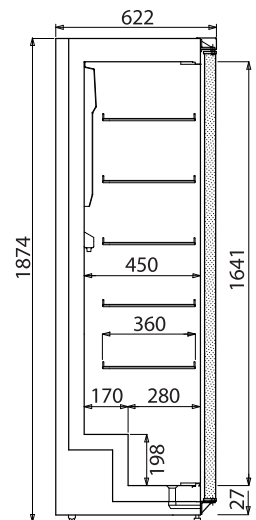

A400 PVS

Suitable
for
fresh
meat



Picture shows Castor
Base option POA



A400 PV

Dimensions	Height:	Width:	Depth:	Weight:	Capacity:
External					
A400PV / PVS.	1860mm.	593mm.	622mm	84kg.343ltr. (12.1cu.ft.)
Internal					
A400PV / PVS.	1641mm.	450mm.	450mm		

MODEL	Description	Price	MODEL	Description	Price
A400PV	White Refrigerator	£841	A400PVS	Stainless Steel Refrigerator	£1022

CHILLED STORAGE

A500 Range

Solid Door Refrigerator

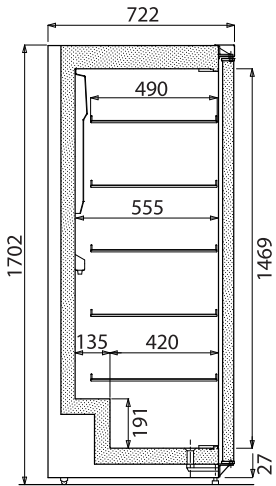

A500 PVS



A500 PV

Suitable for fresh meat



Picture shows Castor Base option POA

Features and Benefits

- * Fan Assisted Cooling
- * Auto Defrost
- * Fully Automatic Operation
- * Replaceable Door Gasket
- * Analogue Temperature Display
- * Lock Fitted
- * Reversible Door (Factory Option)
- * Rollers at Rear
- * Choice of White (PV) or Stainless Steel (PVS)
- * Freezer Option - See Page 157
- * Optional Castor Base (POA)
- * NB. Re-evaporation kit recommended for both high and low ambient conditions
- * Adjustable Temperature

Technical Specifications

- Temperature Range -2/+4°C
- Refrigerant R134
- Type of Defrost Hot Gas
- No. of Shelves 4
- Exterior Finish White or Stainless Steel
- Interior Finish White Steel
- Power Required 13 Amp Supply

Dimensions	Height:	Width:	Depth:	Weight:	Capacity:
External					
A500PV / PVS.	1702mm.	770mm.	720mm.	94kg.521ltr. (18.3cu.ft.)
Internal					
A500PV / PVS.	1494mm.	650mm.	555mm		

MODEL	Description	Price	MODEL	Description	Price
A500PV	White Refrigerator	£967	A500PVS	Stainless Steel Refrigerator	£1182

CHILLED STORAGE

A600 Range

Solid Door Refrigerator

Features and Benefits

- * Fan Assisted Cooling
- * Auto Defrost
- * Fully Automatic Operation
- * Replaceable Door Gasket
- * Analogue Temperature Display
- * Lock Fitted
- * Adjustable Shelving
- * Reversible Door (Factory Option)
- * Rollers at Rear
- * Choice of White (PV) or Stainless Steel (PVS) exterior
- * Freezer Option - See Page 158
- * Suitable for fresh meat
- * Accept 2/1 gastronorm pans or shelves - See Page 184
- * Adjustable Temperature

Technical Specifications

Temperature Range -2/+4°C
Refrigerant R134A
Type of Defrost Fully Automatic
No. of Shelves 4
Exterior Finish White or
 Stainless Steel
Interior Finish White Steel
Power Required 13 Amp Supply



A600PVS



A600PV

Suitable for fresh meat

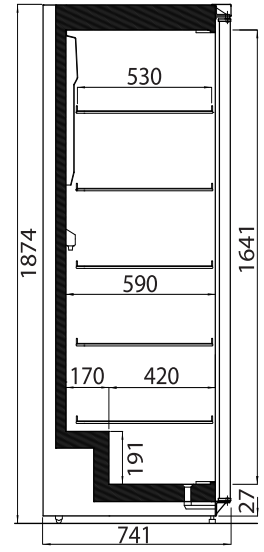

Dimensions	Height:	Width:	Depth:	Weight:	Capacity:
External					
A600PV / PVS.	1874mm.	780mm.	741mm	106kg.620ltr. (21.8cu.ft.)
Internal					
A600PV / PVS.	1641mm.	655mm.	590mm		

MODEL	Description	Price	MODEL	Description	Price
A600PV	White Refrigerator	£1004	A600PVS	Stainless Refrigerator	£1220

CHILLED STORAGE



RK500

Solid Door Refrigerator

Features and Benefits

- * Stainless Steel Interior & Exterior
- * Fully Automatic Operation
- * Adjustable Shelving
- * Replaceable Door Gaskets
- * Digital Temperature Display
- * Lock Fitted
- * Freezer Option - See Page 159

Technical Specifications

Temperature Range -2/+8°C
Refrigerant R134A
Type of Defrost Timed Off Cycle
No. of Shelves 3
Exterior Finish Stainless
Interior Finish Stainless
Power Required 13 Amp Supply



Dimensions	Height:	Width:	Depth:	Weight:	Capacity:
External					
RK500	1900mm	680mm	700mm	130kg	429ltr. (15.14cu.ft.)
Internal					
RK500	1380mm	560mm	553mm		

MODEL	Description	Price
RK500	Stainless	£1099

RK710

Gastronorm Solid Door Refrigerator

Features and Benefits

- * Stainless Steel Interior & Exterior
- * Fully Automatic Operation
- * Replaceable Door Gasket
- * Electronically Controlled
- * Lock Fitted
- * Digital Temperature Display
- * Fan Assisted Cooling
- * Adjustable Shelving
- * Accepts 2/1 Gastronorm - See Page 184
- * Freezer Option - See Page 160
- * Interior Light
- * Fitted Castors
- * Reversible Door
- * Adjustable Temperature

Technical Specifications

Temperature Range . . . -2/+5°C

Refrigerant R134A

Type of Defrost Timed Off Cycle

No. of Shelves 3 (6 on Double Door)

Exterior Finish Stainless Steel

Interior Finish Stainless Steel

Power Required 13 Amp Supply



Suitable
for
fresh
meat



Dimensions	Height:	Width:	Depth:	Weight:	Capacity:
External					
RK710	2010mm	740mm	860mm	134kg	700ltr. (24.7cu.ft.)
Internal					
RK710	1400mm	620mm	700mm		

MODEL	Description	Price
RK710	Stainless Steel	£1233

RK1420

Gastronorm Solid Door Refrigerator

Features and Benefits

- * Stainless Steel Interior & Exterior
- * Fully Automatic Operation
- * Replaceable Door Gasket
- * Electronically Controlled
- * Lock Fitted
- * Digital Temperature Display
- * Fan Assisted Cooling
- * Fully Adjustable Shelving
- * Accepts 2/1 Gastronorm - See page 184
- * Freezer Option - See Page 161
- * Interior Light
- * Fitted Castors
- * Adjustable Temperature

Technical Specifications

Temperature Range	-2/+5°C
Refrigerant	R134A
Type of Defrost	Timed Off Cycle
No. of Shelves	6 (3 per side)
Exterior Finish	Stainless Steel
Interior Finish	Stainless Steel
Power Required	13 Amp Supply



Suitable for fresh meat

RK1420



Dimensions	Height:	Width:	Depth:	Weight:	Capacity:
External					
RK1420	2010mm	1480mm	860mm	198kg	1420ltr. (50.1cu.ft.)
Internal					
RK1420	1400mm	1360mm	700mm		

MODEL	Description	Price
RK1420	Stainless Steel	£1887

Capricorn 500

Solid Door Refrigerator

Features and Benefits

- * Stainless Steel Interior
- * Fully Automatic Operation
- * Replaceable Door Gasket
- * Electronically Controlled
- * Lock Fitted
- * Digital Temperature Display
- * Auto Defrost
- * Twin Fans
- * Fan Assisted Cooling
- * Adjustable Shelving
- * Freezer Option - See Page 162
- * Reversible Door
- * Adjustable Temperature

Technical Specifications

Temperature Range -2/+2°C

Refrigerant R134A

Type of Defrost Electric

No. of Shelves 5

Exterior Finish White or
Stainless Steel

Interior Finish Stainless Steel

Power Required 13 Amp Supply

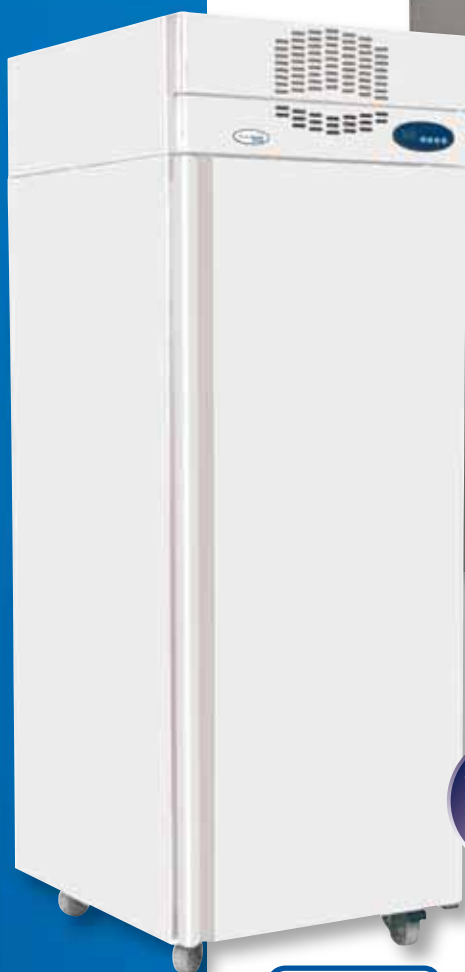

CAR500 W



CAR500 S

Suitable for fresh meat



Dimensions	Height:	Width:	Depth:	Weight:	Capacity:
External					
CAR500	2000mm.	710mm.	700mm	152kg	500ltr. (17.6cu.ft.)
Internal					
CAR500	1480mm.	590mm.	580mm		

N.B. Does Not Accept Gastronorm Trays

MODEL	Description	Price	MODEL	Description	Price
CAR500 W	White	£1251	CAR500 S	Stainless Steel	£1419

Capricorn 1100

Solid Door Refrigerator

Features and Benefits

- * Stainless Steel Interior
- * Fully Automatic Operation
- * Replaceable Door Gasket
- * Electronically Controlled
- * Lock Fitted
- * Digital Temperature Display
- * Auto Defrost
- * Twin Fans
- * Fan Assisted Cooling
- * Adjustable Shelving
- * Freezer Option - See Page 163
- * Adjustable Temperature

Technical Specifications

Temperature Range -2/+5°C
Refrigerant R134A
Type of Defrost Electric
No. of Shelves 5
Exterior Finish White or
 Stainless Steel
Interior Finish Stainless Steel
Power Required 13 Amp Supply



CAR1100S



CAR1100W

Suitable
for
fresh
meat



Dimensions	Height:	Width:	Depth:	Weight:	Capacity:
External					
CAR1100	2000mm	1420mm	700mm	244kg	1100ltr. (38.8cu.ft.)
Internal					
CAR1100	1480mm	1300mm	580mm		

N.B. Does Not Accept Gastronorm Trays

MODEL	Description	Price	MODEL	Description	Price
CAR1100W	White	£1797	CAR1100S	Stainless Steel	£2196

Capricorn 600

Gastronorm Solid Door Refrigerator

Features and Benefits

- * Fully Automatic Operation
- * Electronically Controlled
- * Stainless Steel Interior
- * Replaceable Door Gasket
- * Fitted Castors for Easy Movement
- * Digital Temperature Display
- * Fan Assisted Cooling
- * Suitable for use in High Ambient Locations
- * Adjustable Shelving
- * Lock Fitted
- * Stainless & White Exterior Versions Available
- * Freezer Option - See Page 164
- * Reversible Door
- * Adjustable Temperature

Technical Specifications

Temperature Range . . . -2/+5°C
Refrigerant R134A
Type of Defrost Electric
No. of Shelves 5
Exterior Finish White or Stainless Steel
Interior Finish Stainless Steel
Power Required 13 Amp Supply



CAR600S



CAR600W

Suitable for fresh meat



Unit Accepts up to 2/1 Gastronorm See Page 184

Dimensions	Height:	Width:	Depth:	Weight:	Capacity:
External					
CAR600/S	2000mm.	710mm.	800mm	160kg	600ltr. (21.2cu.ft.)
Internal					
CAR600/S	1480mm.	590mm.	680mm		

MODEL	Description	Price	MODEL	Description	Price
CAR600W	White	£1292	CAR600S	Stainless Steel	£1499

CHILLED STORAGE

Capricorn 1300

Gastronom Solid Door Refrigerator



CAR1300S

Dual
Temperature
CARF/CARM

Suitable
for
fresh
meat



CAR1300W



Glass door version
See page 25

Features and Benefits

- * Dual Temperature (CARF/ CARM1300)
- * Fully Automatic Operation
- * Electronically Controlled
- * Stainless Steel Interior
- * Replaceable Door Gasket/s
- * Fitted Castors
- * Digital Temperature Display
- * Fan Assisted Cooling
- * Suitable for use in High Ambient Locations
- * Adjustable Shelving
- * Self Closing Doors
- * Lock Fitted
- * Stainless & White Exterior Versions Available
- * Freezer Option - See Page 165
- * Adjustable Temperature

Technical Specifications

Temperature Range

CAR1300/S -2/+5°C
CARF1300/S -2/+5°C
-18/-21°C

CARM1300/S -2/+2°C
0/+5°C

Refrigerant R134A
R404A
(CARF Models)

Type of Defrost Electric

No of Shelves

CAR1300/S 10 + 5
+ intermediate

CARF1300/S 5 per door

CARM1300/S 5 per door

Exterior Finish White or
Stainless Steel

Interior Finish Stainless steel

Power Required 13 Amp Supply

Dimensions	Height:	Width:	Depth:	Weight:	Capacity:
External					
CAR1300/S	2000mm	1420mm	800mm	252kg	1300ltr. (45.9cu.ft.)
CARF1300/S	2000mm	1420mm	800mm	297kg	2 x 525ltr. (18.5cu.ft.)
CARM1300/S	2000mm	1420mm	800mm	297kg	2 x 525ltr. (18.5cu.ft.)
Internal					
CAR1300/S	1480mm	1300mm	680mm		
CARF1300/S	1480mm	2x600mm	680mm		
CARM1300/S	1480mm	2x600mm	680mm		

MODEL	Description	Price	MODEL	Description	Price
CAR1300W	White	£1893	CARF1300S	Stainless Refrigerator/Freezer	£3211
CAR1300S	Stainless	£2328	CARM1300W	White Dual Temp	£2792
CARF1300W	White Refrigerator/Freezer	£2869	CARM1300S	Stainless Dual Temp	£3100

SQ Range

Blast Chiller Shock Freezer

Features and Benefits

- * Fully Automatic Operation
- * Electronically Controlled
- * Touch Pad Controls for Simple Operation
- * 100 Program Memory
- * Soft Chill / Hard Chill Program Option
- * Fan Assisted Cooling
- * Adjustable Feet
- * Temperature Probe Supplied
- * Suitable for High Ambient Locations
- * Rounded Interior Corners for Easy Cleaning
- * Shelf Racks Easily Removed for Cleaning
- * Simple Access to Fans for Cleaning
- * Accepts 1/1 Gastronorm and 60x40 Euronorm Pans
(SQ3 only accepts gastronorm pans)

Technical Specifications

Refrigerant R404A
 Type of Defrost Off Cycle
 Exterior Finish Stainless Steel
 Interior Finish Stainless Steel



SQ3

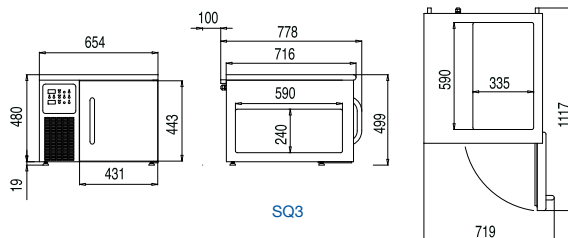

SQ5

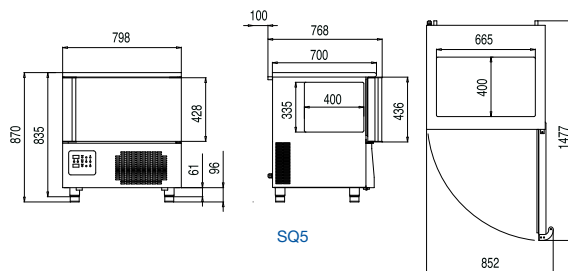

Model:	Trays:	Chill/Freeze Capacity:	Power Req:	Power Cons:	Weight:
	1/1 G'Norm or 60x40 E'Norm	(+70°C to +3°C) (-70°C to -18°C)			
SQ3 (G'Norm only) 3 10kg - 90 mins 5kg - 240 mins 20amp 0.8kW 61kg
SQ5 5 20kg - 90 mins 12kg - 240 mins 20amp 1.2kW 102kg

MODEL	Description	Price	MODEL	Description	Price
SQ3	Stainless Steel	£2544	SQ5	Stainless Steel	£3506

SQ Range

Blast Chiller Shock Freezer

Features and Benefits

- * Fully Automatic Operation
- * Electronically Controlled
- * Touch Pad Controls for Simple Operation
- * Soft Chill / Hard Chill Program Option
- * 100 Program Memory
- * Fan Assisted Cooling
- * Adjustable Feet
- * Temperature Probe Supplied
- * Suitable for High Ambient Locations
- * Rounded Interior Corners for Easy Cleaning
- * Shelf Racks Easily Removed for Cleaning
- * Simple Access to Fans for Cleaning
- * Accepts 1/1 Gastronorm and 60x40 Euronorm Pans

Technical Specifications

Refrigerant R404A
 Type of Defrost Off Cycle
 Exterior Finish Stainless Steel
 Interior Finish Stainless Steel



SQ7



Portable Printer Suitable for all units £792

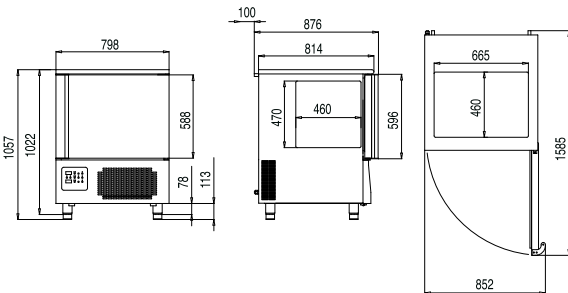

Model:	Trays:	Chill/Freeze Capacity:	Power Req:	Power Cons:	Weight:
SQ7	1/1 G'Norm or 60x40 E'Norm	(+70°C to +3°C) (+70°C to -18°C)	20amp	1.3kW	130kg

MODEL	Description	Price
SQ7	Stainless Steel	£3984

CHILLED STORAGE

SQ Range

Blast Chiller Shock Freezer

Features and Benefits

- * Fully Automatic Operation
- * Electronically Controlled
- * Touch Pad Controls for Simple Operation
- * Soft Chill / Hard Chill Program Option
- * 100 Program Memory
- * Fan Assisted Cooling
- * Adjustable Feet
- * Temperature Probe Supplied
- * Suitable for High Ambient Locations
- * Rounded Interior Corners for Easy Cleaning
- * Shelf Racks Easily Removed for Cleaning
- * Simple Access to Fans for Cleaning
- * Accepts 1/1 Gastronorm and 60x40 Euronorm Pans

Technical Specifications

Refrigerant R404A
 Type of Defrost Off Cycle
 Exterior Finish Stainless Steel
 Interior Finish Stainless Steel



SQ10



SQ14

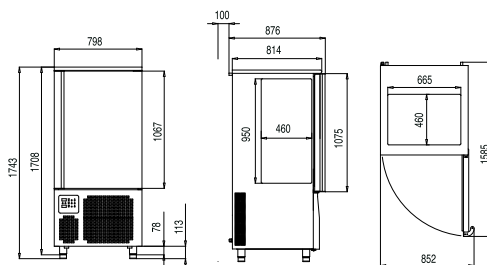

SQ10 / SQ14



SQ10+10

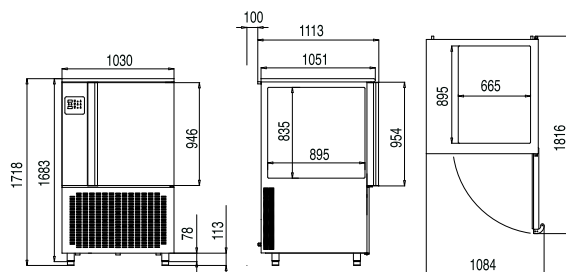

SQ10+10



SQ10+10 Accepts 20 1/1 G'Norm or 20 E'Norm Pans



Portable Printer Suitable for all units £792



CHILLED STORAGE

Model:	Trays:	Chill/Freeze Capacity:	Power Req:	Power Cons:	Weight:
	1/1 G'Norm or 60x40 E'Norm	(+70°C to +3°C) (+70°C to -18°C)			
SQ101040kg - 90 mins 25kg - 240 mins 3 phase 2kW 205kg
SQ141450kg - 90 mins 30kg - 240 mins 3 phase 2.2kW 210kg
SQ10+102080kg - 90 mins 50kg - 240 mins 3 phase 2.5kW 280kg

MODEL	Description	Price	MODEL	Description	Price
SQ10	Stainless Steel	£6049	SQ10+10	Stainless Steel	£9401
SQ14	Stainless Steel	£7574			

ORDER

ORDER

SQ Range

Blast Chiller Shock Freezer

Features and Benefits

- * Fully Automatic Operation
- * Electronically Controlled
- * Touch Pad Controls for Simple Operation
- * Soft Chill / Hard Chill Program Option
- * 100 Program memory
- * Fan Assisted Cooling
- * Adjustable Feet
- * Temperature Probe Supplied
- * Suitable for High Ambient Locations
- * Rounded Interior Corners for Easy Cleaning
- * Simple Access to Fans for Cleaning
- * Accepts Gastronorm and Euronorm Trolleys (Not Supplied)
- * All SQ20 cabinets are supplied with remote refrigeration unit. This must be mounted within 10m of the cabinet and will require installation by an engineer

Technical Specifications

Refrigerant R404A
Type of Defrost Off Cycle
Exterior Finish Stainless Steel
Interior Finish Stainless Steel



SQ7



Optional Built in printer/graphic recorder for SQ10 and larger
£843

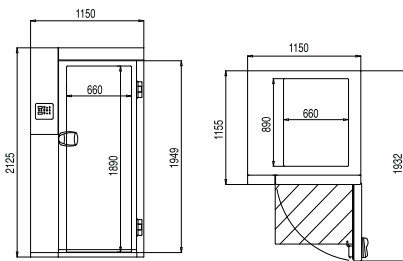

SQ20+80 / SQ20-100

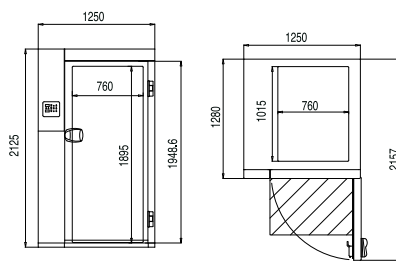

SQ20-170

Model:	Trays:	Chill/Freeze Capacity:		Power Req:	Power Cons:	Weight:
	1/1 G'Norm or 60x40 E'Norm	(+70°C to +3°C)	(+70°C to -18°C)			
SQ20-802080kg - 90 mins	50kg - 240 mins 3 phase	3kW	260kg
SQ20-10020	100kg - 90 mins	60kg - 240 mins 3 phase	5kW	260kg
SQ20-17040	170kg - 90 mins	120kg - 240 mins 3 phase	6.7kW	280kg

MODEL	Description	Price	MODEL	Description	Price
SQ20-80	Stainless Steel	£13175	SQ20-170	Stainless Steel	£20342
SQ20-100	Stainless Steel	£14709			

SA910

Gastronorm Counter

Features and Benefits

- * Stainless Steel Interior/Exterior
- * Fan Assisted Cooling
- * Gastronorm Pans Available - Not Supplied - See Page 184
- * Digital Temperature Display
- * Adjustable Temperature

Technical Specifications

Temperature Range . . . +2/+6°C
Refrigerant R134A
Type of Defrost Off Cycle
No. of Shelves 1 per door
Exterior Finish Stainless Steel
Interior Finish Stainless Steel
Power Required 13 Amp Supply



SA910

Dimensions	Height:	Width:	Depth:	Weight:	Capacity:
External SA910	875mm	900mm	700mm	72kg	260ltr. (9.18cu.ft.)

MODEL	Description	Price
SA910	Stainless Steel	£975

PT920

Gastronorm Pizza Preparation Counters

Features and Benefits

- * Stainless Steel Interior/Exterior
- * Fan Assisted Cooling
- * Gastronorm Pans Available - Not Supplied - See Page 184
- * Digital Temperature Display
- * Adjustable Temperature

Technical Specifications

Temperature Range . . . +2/+6°C
Refrigerant R134A
Type of Defrost Off Cycle
No. of Shelves 1 per door
Exterior Finish Stainless Steel
Interior Finish Stainless Steel
Power Required 13 Amp Supply



PT920

Dimensions	Height:	Width:	Depth:	Weight:	Capacity:
External PT920	1075mm	900mm	700mm	114kg	260ltr. (9.18cu.ft.)

MODEL	Description	Price
PT920	Stainless Steel	£992



Gastronorm pans available in all sizes (P.O.A.)
See p184 for details

CHILLED STORAGE

SA920 / 1045

Gastronorm Saladette Counter



Features and Benefits

- * Stainless Steel Interior/Exterior
- * Adjustable Feet
- * Gastronorm Pans Available - Not Supplied - See Page 184
- * Fan Assisted Cooling
- * Polypropylene Chopping Board
- * Digital Temperature Display
- * 1/1 Gastronorm Cupboards
- * Adjustable Temperature

Technical Specifications

Temperature Range +2/+6°C
Refrigerant R134A
Type of Defrost Off Cycle
No. of Shelves 1 per door
Exterior Finish Stainless Steel
Interior Finish Stainless Steel
Power Required 13 Amp Supply

SA920



SA1045

Well Dimensions

SA920/GC 826mm x 530mm
 SA1045 975mm x 530mm

Dimensions	Height:	Width:	Depth:	Weight:	Capacity:
External					
SA920	850mm	900mm	700mm	70kg260ltr. (9.18cu.ft.)
SA920GC	1030mm	900mm	700mm	70kg260ltr. (9.18cu.ft.)
SA1045	850mm	1045mm	700mm	98kg260ltr. (9.18cu.ft.)

MODEL	Description	Price	MODEL	Description	Price
SA920	Stainless Steel	£1038	SA1045	Stainless Steel	£1081

SA 1365

Gastronorm Counter



SA1365

Features and Benefits

- * Stainless Steel Interior/Exterior
- * Adjustable Feet
- * Gastronorm Pans Available - Not Supplied - See Page 184
- * Fan Assisted Cooling
- * Digital Temperature Display
- * Adjustable Temperature

Technical Specifications

Temperature Range +2/+6°C
Refrigerant R134A
Type of Defrost Off Cycle
No. of Shelves 1 per door
Exterior Finish Stainless Steel
Interior Finish Stainless Steel
Power Required 13 Amp Supply

Dimensions	Height:	Width:	Depth:	Weight:	Capacity:
External					
SA1365	850mm	1365mm	700mm	130kg400ltr. (14.1cu.ft.)

MODEL	Description	Price
SA1365	Stainless Steel	£1432

R2

Gastronorm Counter



Features and Benefits

- * Stainless Steel Interior/Exterior
- * Fan Assisted Cooling
- * Adjustable Temperature
- * Digital Temperature Display
- * Adjustable Shelving
- * Replaceable Door Gaskets
- * Splashback as Standard

Technical Specifications

Temperature Range +2/+8°C
Refrigerant R134A
Type of Defrost Off Cycle
No. of Shelves 1 per door
Exterior Finish Stainless Steel
Interior Finish Stainless Steel
Power Required 13 Amp Supply

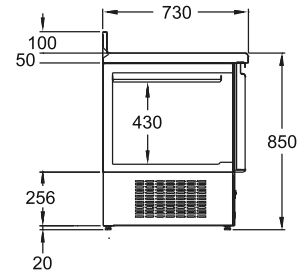

R2



Dimensions External	Height:	Width:	Depth:	Weight:	Capacity:
R2	850mm	880mm	700mm	90kg	148ltr. (5.22cu.ft.)

MODEL	Description	Price
R2	Stainless Steel	£1298

R3

Gastronorm Pizza Preparation Counter



Features and Benefits

- * Stainless Steel Interior/Exterior
- * Fan Assisted Cooling
- * Adjustable Temperature
- * Digital Temperature Display
- * Adjustable Shelving
- * Replaceable Door Gaskets
- * Granite Worktop as Standard
- * Gastronorm Pans Available - Not Supplied - See Page 184

Technical Specifications

Temperature Range +2/+8°C
Refrigerant R134A
Type of Defrost Off Cycle
No. of Shelves 1 per door
 Cut out will accept 5 x 1/6 GN Pans 100mm Deep Maximum (not included)
Exterior Finish Stainless Steel
Interior Finish Stainless Steel
Power Required 13 Amp Supply

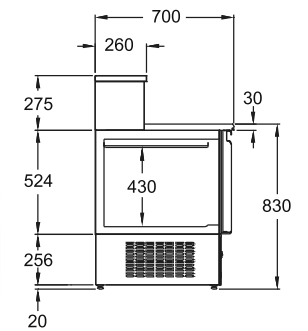

R3



Dimensions External	Height:	Width:	Depth:	Weight:	Capacity:
R3	1074mm	880mm	700mm	148kg	102ltr. (5.22cu.ft.)

MODEL	Description	Price
R3	Stainless	£1339

CHILLED STORAGE



New product



R1

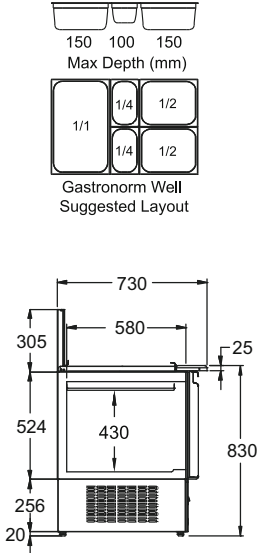

Dimensions	Height:	Width:	Depth:	Weight:	Capacity:
External					
R1	830/1135mm	880mm	730mm	76kg	148ltr. (5.22cu.ft.)

MODEL	Description	Price
R1	Stainless Steel	£1309

R1

Gastronorm Saladette Counter

Features and Benefits

- * Stainless Steel Interior/Exterior
- * Fan Assisted Cooling
- * Adjustable Temperature
- * Digital Temperature Display
- * Adjustable Shelving
- * Replaceable Door Gaskets
- * Polypropylene Chopping Board
- * Gastronorm Pans Available - Not Supplied - See Page 184

Technical Specifications

Temperature Range +2/+8°C
 Refrigerant R134A
 Type of Defrost Off Cycle
 No. of Shelves 1 per door
 Exterior Finish Stainless Steel
 Interior Finish Stainless Steel
 Power Required 13 Amp Supply



New product



R4

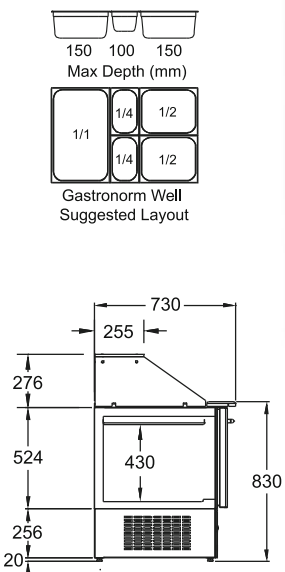

Dimensions	Height:	Width:	Depth:	Weight:	Capacity:
External					
R4	1076mm	880mm	730mm	87kg	148 ltr. (5.22cu.ft.)

MODEL	Description	Price
R4	Stainless Steel	£1379

R4

Gastronorm Saladette Counter

Features and Benefits

- * Stainless Steel Interior/Exterior
- * Fan Assisted Cooling
- * Adjustable Temperature
- * Digital Temperature Display
- * Adjustable Shelving
- * Replaceable Door Gaskets
- * Polypropylene Chopping Board
- * Gastronorm Pans Available - Not Supplied - See Page 184

Technical Specifications

Temperature Range +2/+8°C
 Refrigerant R134A
 Type of Defrost Off Cycle
 No. of Shelves 1 per door
 Exterior Finish Stainless Steel
 Interior Finish Stainless Steel
 Power Required 13 Amp Supply

CHILLED STORAGE

CK Range

Gastronorm Refrigerated Counter

Features and Benefits

- * Stainless Steel Exterior 304 Grade
- * Injected Polyurethane Insulation
- * Fitted Castors
- * Digital Temperature Display
- * Compressor on Indicator
- * Gastronorm Pans Available - Not Supplied - See Page 184
- * 1/1 Gastronorm Size
- * Fitted Splashback
- * Freezer Option - See Page 166
- * Adjustable Temperature

Technical Specifications

Temperature Range . . . -2/+8°C
Refrigerant R134A
Type of Defrost Electric
No. of Shelves 1 per Door
Exterior Finish Stainless Steel
Interior Finish Stainless Steel
Power Required 13 Amp Supply



CK7210



CK7310

Suitable for fresh meat

2 Year

Dimensions	Height inc. Splashback:	Height not inc. Splashback:	Width:	Depth:	Weight:	Capacity:
External						
CK 7210 2 Door950mm850mm1360mm700mm98kg265ltr. (9.35cu.ft.)
CK 7310 3 Door950mm850mm1795mm700mm134kg400ltr. (14.1cu.ft.)
CK 7410 4 Door950mm850mm2230mm700mm153kg520ltr. (18.4cu.ft.)

MODEL	Description	Price	MODEL	Description	Price
CK 7210 2 Door	Stainless Steel	£1219	CK 7410 4 Door	Stainless Steel	£1778
CK 7310 3 Door	Stainless Steel	£1454			

CHILLED STORAGE

SS Range

Refrigerated Preparation Counter

Features and Benefits

- * Stainless Steel Exterior
- * Injected Polyurethane Insulation
- * Lockable Castors
- * Digital Temperature Display
- * Gastronorm Pans Available - Not Supplied - See Page 184
- * Accepts 1/3 Size Gastronorm Pans
- * Adjustable Temperature
- * SS7200 = 6x 1/3 pans max 150mm deep
- * SS7300 = 9x 1/3 pans max 150mm deep

Technical Specifications

Temperature Range +2/+8°C
Refrigerant R134A
Type of Defrost Off Cycle
Exterior Finish Stainless Steel
Interior Finish Stainless Steel
Power Required 13 Amp Supply



SS7300

Dimensions	Height:	Width:	Depth:	Workspace Depth:	Weight:	Capacity:
External						
SS 7200	1050mm	1360mm	700mm	305mm	145kg	265ltr. (9.35cu.ft.)
SS 7300	1050mm	1795mm	700mm	305mm	155kg	400ltr. (14.1cu.ft.)

MODEL	Description	Price	MODEL	Description	Price
SS 7200	2 Door Gastronorm SS	£1699	SS 7300	3 Door Gastronorm SS	£2116

L2 Range

Gastronorm Refrigerated Counter

Features and Benefits

- * Stainless Steel Exterior 304 Grade
- * Injected Polyurethane Insulation
- * 1 Shelf per Door (Max 7 Shelves)
- * Fitted Castors
- * Various Combinations of Doors and Drawers available - Factory Order Only
- * Hermetic Compressor
- * Digital Temperature Display
- * Compressor on Indicator
- * Switchable Static or Ventilated Cooling
- * Gastronorm Pans Available - Not Supplied - See Page 184
- * 1/1 Gastronorm Size
- * Splashback - (Factory Option)
- * Freezer Option See Page 167

Technical Specifications

Temperature Range . . . -2/+8°C
Refrigerant R134A
Type of Defrost Electric
Exterior Finish Stainless Steel
Interior Finish Stainless Steel
Power Required 13 Amp Supply
High Ambient 42°C



L2-1320 plus
Splashback

Suitable
for
fresh
meat



L2-1320



Splashback & Drawer Options

L2-1755



L2-1755 plus Splashback



CHILLED STORAGE

L2 Range

Gastronorm Refrigerated Counter

Splashback & Drawer options



L2-2190 plus Splashback

Suitable for fresh meat



L2-2190



Remote options (P.O.A.)
Remote units(R) come complete with condensing unit, expansion valve and control panel for up to 10m runs
NB. Topping Units are now available for all lengths, see page 143, mounting kit required

Factory Options

Half drawers per door	£327
Third drawers per door	£452
Splashback L2-1320	£126
L2-1755	£165
L2-2190	£184
L2-2625	£196



Gastronorm pans available in all sizes (P.O.A.)
See p184 for details

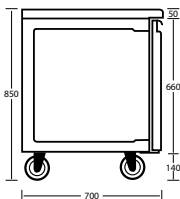

Dimensions	Height:	Width:	Depth:	Capacity:	Weight:
External					
L2-1320 2 Door . . .	850mm	1320mm	700mm	189kg	263ltr. (9.2cu.ft.)
L2-1755 3 Door . . .	850mm	1755mm	700mm	217kg	410ltr. (14.4cu.ft.)
L2-2190 4 Door . . .	850mm	2190mm	700mm	251kg	555ltr. (19.5cu.ft.)
L2-2625 5 Door . . .	850mm	2625mm	700mm	285kg	712ltr. (25cu.ft.)
Internal					
L2-1320 2 Door . . .	565mm	796mm	585mm		
L2-1755 3 Door . . .	565mm	1239mm	585mm		
L2-2190 4 Door . . .	565mm	1681mm	585mm		
L2-2625 5 Door . . .	565mm	2157mm	585mm		

MODEL	Description	Price	MODEL	Description	Price
L2-1320 2 DOOR	Stainless Steel	£1755	L2-2190 4 DOOR	Stainless Steel	£2719
L2-1755 3 DOOR	Stainless Steel	£2186	L2-2625 5 DOOR	Stainless Steel	£3244

ORDER

CHILLED STORAGE

Scorpion

Gastronorm Refrigerated Counter

Features and Benefits

- * Fully Automatic Operation
- * Electronically Controlled
- * Stainless Steel Interior & Exterior
- * Fitted Castors
- * Fan Assisted Cooling
- * Suitable for use in High Ambient Locations
- * Adjustable Shelving
- * Digital Temperature Display
- * Drawer Sections (Factory Option)
- * Splashbacks (Factory Option)
- * Freezer Option - See Page 167
- * 1/1 Gastronorm Size
- * Adjustable Temperature

Technical Specifications

Temperature Range . . . -2/+2°C

Refrigerant R134A

Type of Defrost Electric

No. of Shelves 1/1 Gastronorm

PH2 - SCORPIO 2

PH3 - SCORPIO 3

PH4 - SCORPIO 4

Exterior Finish Stainless Steel

Interior Finish Stainless Steel

Power Required 13 Amp Supply

Splashback Option



Drawer Options



1/3 Drawers



1/2 Drawers



Gastronorm pans available in all sizes (P.O.A.)
See p184 for details



PH2

Suitable for fresh meat



Dimensions	Height:	Width:	Depth:	Weight:	Capacity:
External					
PH2 - 2 door	850mm	1356mm	700mm	159kg262ltr. (9.2cu.ft.)
PH3 - 3 door	850mm	1834mm	700mm	194kg410ltr. (14.4cu.ft.)
PH4 - 4 door	850mm	2312mm	700mm	210kg560ltr. (19.7cu.ft.)
Internal					
PH2	540mm	836mm	530mm		
PH3	540mm	1314mm	530mm		
PH4	540mm	1792mm	530mm		

Scorpio

Gastronorm Refrigerated Counter



PH3

Suitable for fresh meat



PH4

2 Year Parts Warranty

Factory Options	
Half drawers per door	£325
Third drawers per door	£432
Splashback PH2	£112
PH3	£162
PH4	£177

MODEL	Description	Price	MODEL	Description	Price
PH2	2 DOOR	£1640	PH4	4 DOOR	£2479
PH3	3 DOOR	£1994			

CHILLED STORAGE

PT Range

Gastronorm Preparation Table

Features and Benefits

- * Stainless Steel Construction with Granite Worktop
- * Digital Thermometer
- * Doors Accept 600mm x 400mm Euronorm Trays
- * Fan Assisted Cooling
- * Topping Unit Accepts 1/3 Gastronorm Pans (Not Supplied) - See Page 184
- * Lockable Castors
- * 1 Shelf per Door (600 x 400mm)
- * Adjustable Temperature

Technical Specifications

Temperature Range . . . +2/+5°C
Refrigerant R134A
Type of Defrost Off Cycle
Exterior Finish Stainless Steel
Interior Finish Stainless Steel



PT1200



PT1300



PT1310

Dough Drawers are Ambient



Dimensions	Height:	Width:	Depth:	Weight:	Capacity:
External					
PT1200	1415mm	1510mm	800mm	257kg390ltr. (13.7cu.ft.)
PT1300	1415mm	2045mm	800mm	352kg580ltr. (20.4cu.ft.)
PT1310	1415mm	2045mm	800mm	362kg390ltr. (13.7cu.ft.)

MODEL	Description	Price	MODEL	Description	Price
PT1200	Stainless Steel 2 door	£2212	PT1310	Stainless Steel	£2861
PT1300	Stainless Steel 3 door	£2568			

CHILLED STORAGE

VK Range

Gastronorm Topping Shelves



Gastronorm pans available in all sizes (P.O.A.)
See p184 for details

Features and Benefits

- * Stainless Steel Exterior
- * Digital Temperature Display
- * Accepts 1/4 Gastronorm Pans (Not Supplied) - See Page 184
- * Adjustable Feet for Easy Levelling
- * Adjustable Temperature

Technical Specifications

Temperature Range . . . -1/+5°C
 Refrigerant R134A
 Type of Defrost Off Cycle
 Exterior Finish Stainless Steel
 Interior Finish Stainless Steel
 Power Required 13 Amp Supply



VK33-180

Image Shows Unit with 1/4 Size Gastronorm Pans (not Supplied) see Page 184



VK33-120



Dimensions	Height:	Width:	Depth:	Weight:	Gastro Pans (1/4 Size):
External					
VK33-120	435mm	1200mm	335mm	25kg	5
VK33-150	435mm	1500mm	335mm	29kg	6
VK33-160	435mm	1600mm	335mm	30kg	7
VK33-180	435mm	1800mm	335mm	32kg	9
VK33-200	435mm	2000mm	335mm	34kg	10

MODEL	Description	Price	MODEL	Description	Price
VK33-120	Stainless Steel	£586	VK33-180	Stainless Steel	£675
VK33-150	Stainless Steel	£609	VK33-200	Stainless Steel	£697
VK33-160	Stainless Steel	£671			

L5 Range

Gastronorm Saladette
Refrigerated Counter

Features and Benefits

- * Stainless Steel Exterior
- * Injected Polyurethane Insulation
- * Five Stainless Steel Non Tipping 'L' Shaped Guides Per Door
- * 1/1 Gastronorm Size
- * Castors
- * Hermetic Compressor
- * Digital Temperature Display
- * Compressor on Indicator
- * Polypropylene Chopping Board
- * Gastronorm Pans Available - Not Supplied - See Page 184
- * Switchable Static or Ventilated Cooling
- * Ambient Drawer above compressor
- * Adjustable Temperature

Technical Specifications

Temperature Range . . . +2/+8°C
Refrigerant R134A
Type of Defrost Off Cycle
Exterior Finish Stainless Steel
Interior Finish Stainless Steel
Power Required 13 Amp Supply
High Ambient 40°C



Gastronorm pans available in all sizes (P.O.A.)
See p184 for details

Remote units(R) come complete with condensing unit, expansion valve and control panel for up to 10m runs



L5-1320



Dimensions	Height:	Width:	Depth:	Weight:	Capacity:
External					
L5-1320 2 Door . . .	850mm	1320mm	700mm	183kg313ltr. (11cu.ft.)
L5-1755 3 Door . . .	850mm	1755mm	700mm	217kg484ltr. (17cu.ft.)
Internal					
L5-1320 2 Door . . .	565mm	796mm	585mm		
L5-1755 3 Door . . .	565mm	1239mm	585mm		

MODEL	Description	Price	MODEL	Description	Price
L5-1320	Stainless Steel 2 Door	£2029	L5-1755	Stainless Steel 3 Door	£2517
Remote Options		 P.O.A.			

CHILLED STORAGE

L6 Range

Gastronorm Pizza Preparation Counter



L6 2 DOOR

Remote units come complete with condensing unit, expansion valve and control panel for up to 10m runs

E Denotes Base Unit plus Topping Unit

Features and Benefits

- * Stainless Steel Exterior
- * Injected Polyurethane Insulation
- * Four Stainless Steel Non Tipping 'L' Shaped Guides Per Door
- * Castors
- * Hermetic Compressor
- * Digital Temperature Display
- * Compressor on Indicator
- * Switchable Static or Ventilated Cooling
- * Gastronorm Pans Available - Not Supplied - See Page 184
- * Ambient Drawer above compressor
- * 1/1 Gastronorm Size
- * Adjustable Temperature

Technical Specifications

Temperature Range	-2/+8°C
Refrigerant	R134A
Type of Defrost	Electric
Exterior Finish	White or Stainless Steel
Interior Finish	Stainless Steel
Power Required	13 Amp Supply



L6 3 Door (E)

(Standard Unit plus Topping Unit)



L7-1980

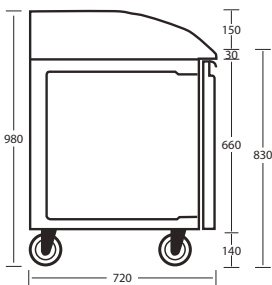

Dimensions	Height:	Height (E):	Width:	Depth:	Weight:	Capacity:
External						
L6 2 Door	980mm	1365mm	1470mm	720mm	243kg	321ltr. (11cu.ft.)
L6 3 Door	980mm	1365mm	1980mm	720mm	318kg	497ltr. (17.5cu.ft.)
L6 4 Door	980mm	1365mm	2490mm	720mm	393kg	673ltr. (24cu.ft.)
Internal						
L6 2 Door	565mm	565mm	954mm	595mm		
L6 3 Door	565mm	565mm	1478mm	595mm		
L6 4 Door	565mm	565mm	2001mm	595mm		

MODEL	Description	Price	MODEL	Description	Price
L6 2 Door	Stainless Steel	£2117	L6 2 Door (E)	Stainless Steel	£3044
L6 3 Door	Stainless Steel	£2694	L6 3 Door (E)	Stainless Steel	£3756
L6 4 Door	Stainless Steel	£3275	L6 4 Door (E)	Stainless Steel	£4481
			Remote Options		P.O.A.

L6 D Range

Gastronorm Preparation Counter

Features and Benefits

- * Stainless Steel Exterior
- * Injected Polyurethane Insulation
- * Four Stainless Steel Non Tipping 'L' Shaped Guides Per Door
- * Castors
- * Hermetic Compressor
- * Digital Temperature Display
- * Compressor on Indicator
- * Switchable Static or Ventilated Cooling
- * Gastronorm Pans Available - Not Supplied - See Page 184
- * Ambient Drawer Above Compressor
- * 1/1 Gastronorm Size
- * Adjustable Temperature

Technical Specifications

Temperature Range . . . -2/+8°C

Refrigerant R134A

Type of Defrost Electric

Exterior Finish Stainless Steel

Interior Finish Stainless Steel

Power Required 13 Amp Supply



L6-D2



L7 Topping Unit



L6-D4E



* N.B L6D2 / L6D2E are supplied with 2 Refrigerated Doors and 3 Dough Drawers above the Unit Compartment

Dimensions	Height:	Height (E):	Width:	Depth:	Weight:	Capacity:
External						
L6 D 2 Door	980mm	1365mm	1600mm	720mm256kg	346ltr. (12.2cu.ft.)
* L6 D 3 Door	980mm	1365mm	1980mm	720mm415kg	497ltr. (17.5cu.ft.)
L6 D 4 Door	980mm	1365mm	2490mm	720mm491kg	673ltr. (24cu.ft.)
Internal						
L6 D 2 Door	565mm	565mm	954mm	595mm		
L6 D 3 Door	565mm	565mm	1478mm	595mm		
L6 D 4 Door	565mm	565mm	2001mm	595mm		

MODEL	Description	Price	MODEL	Description	Price
L6 D 2 Door	Stainless Steel	£2695	L6 D 2 Door (E)	Stainless Steel	£3663
L6 D 3 Door	Stainless Steel	£2994	L6 D 3 Door (E)	Stainless Steel	£4056
L6 D 4 Door	Stainless Steel	£3589	L6 D 4 Door (E)	Stainless Steel	£4795
			L6 D Remote Unit		P.O.A.

CHILLED STORAGE

L7 Range

Gastronorm Topping Shelf

Features and Benefits

- * Stainless Steel Exterior
- * Digital Temperature Display
- * Gastronorm Pans Available - Not Supplied - See Page 184
- * Adjustable Temperature

Technical Specifications

Temperature Range . . . +1/+5°C
 Refrigerant R134A
 Type of Defrost Off Cycle
 Exterior Finish Stainless Steel
 Interior Finish Stainless Steel
 Power Required 13 Amp Supply



Gastronorm pans available in all sizes (P.O.A.)
See p184 for details



L7-1755



Topping Shelf Unit can be purchased as a stand alone unit or comes complete with the L6E Range

Dimensions	Height:	Width:	Depth:	Weight:	Gastronorm 1/4 Pans:
External					
L7-1320	385mm	1320mm	324mm	45kg	5
L7-1470	385mm	1470mm	324mm	50kg	6
L7-1600	385mm	1600mm	324mm	55kg	7
L7-1755	385mm	1755mm	324mm	60kg	8
L7-1980	385mm	1980mm	324mm	70kg	9
L7-2190	385mm	2190mm	324mm	80kg	10
L7-2490	385mm	2490mm	324mm	90kg	12
L7-2625	385mm	2625mm	324mm	95kg	13
L7-3000	385mm	3000mm	324mm	110kg	15
Internal					
L7-1320	171mm	838mm	244mm		
L7-1470	171mm	988mm	244mm		
L7-1600	171mm	1118mm	244mm		
L7-1755	171mm	1273mm	244mm		
L7-1980	171mm	1498mm	244mm		
L7-2190	171mm	1708mm	244mm		
L7-2490	171mm	2008mm	244mm		
L7-2625	171mm	2143mm	244mm		
L7-3000	171mm	2518mm	244mm		

MODEL	Description	Price	MODEL	Description	Price
L7-1320	Stainless Steel	£899	L7-2190	Stainless Steel	£1108
L7-1470	Stainless Steel	£927	L7-2490	Stainless Steel	£1206
L7-1600	Stainless Steel	£968	L7-2625	Stainless Steel	£1245
L7-1755	Stainless Steel	£1008	L7-3000	Stainless Steel	£1369
L7-1980	Stainless Steel	£1062			

S1 Pizza Prep

Gastronorm Pizza Preparation Counter

Features and Benefits

- * Stainless Steel Exterior
- * Injected Polyurethane Insulation
- * Four Stainless Steel Non Tipping 'L' Shaped Guides per Door
- * Castors
- * Hermetic Compressor
- * Digital Temperature Display
- * Compressor on Indicator
- * Switchable Static or Ventilated Cooling
- * Gastronorm Pans Available - Not Supplied - See Page 184
- * Gastro well takes 1/3 size Gastronorm Pans upto 150mm deep
- * Adjustable Temperature
- * Separately Adjustable Temperature for Counter & Topping Unit

Technical Specifications

Temperature Range . . . -2/+8°C

Refrigerant R134A

Type of Defrost Electric

Exterior Finish Stainless Steel

Interior Finish Stainless Steel

Power Required 13 Amp Supply



S1 1470 PIZZA PREP



S1 1980 PIZZA PREP



Dimensions	Height:	Width:	Depth:	Workspace Depth	Weight:	Capacity:
External						
S1 1470 2 door . . .	1060mm	1470mm	800mm	410mm	205kg	351.9ltr. (12.4cu.ft.)
S1 1980 3 door . . .	1060mm	1980mm	800mm	410mm	245kg	536.18ltr. (18.9cu.ft.)
S1 2490 4 door . . .	1060mm	2490mm	800mm	410mm	285kg	717.83ltr. (25.3cu.ft.)
S1 3000 5 door . . .	1060mm	3000mm	800mm	410mm	325kg	899.92ltr. (31.7cu.ft.)
Internal						
S1 1470	570mm	930mm	610mm			
S1 1980	570mm	1440mm	610mm			
S1 2490	570mm	1950mm	610mm			
S1 3000	570mm	2460mm	610mm			

MODEL	Description	Price	MODEL	Description	Price
S1 1470	Stainless Steel	£2282	S1 2490	Stainless Steel	£3669
S1 1980	Stainless Steel	£2978			

CHILLED STORAGE



L8 Range

Gastronorm Sandwich Counter

Features and Benefits

- * Stainless Steel Interior/Exterior
- * Fan Assisted Cooling
- * Adjustable Temperature
- * Digital Temperature Display
- * Adjustable Shelving
- * Replaceable Door Gaskets
- * Granite Worktop
- * Gastronorm Pans Available - Not Supplied - See Page 184
- * Ambient Drawer Above Unit Compartment

Technical Specifications

Temperature Range +2/+8°C

Refrigerant R134A

Type of Defrost Off Cycle

No. of Shelves

L8 1 per Door

L8-1320 Cut out will accept 5 x 1/4 GN Pans 150mm Deep Maximum (not included)

L8-1755 Cut out will accept 7 x 1/4 GN Pans 150mm Deep Maximum (not included)

Exterior Finish Stainless Steel

Interior Finish Stainless Steel

Power Required 13 Amp Supply



L8-1320



L8-1755

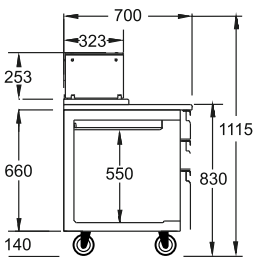

Dimensions	Height:	Width:	Depth:	Weight:	Capacity:
External					
L8-1320	1110mm	1320mm	700mm	191kg	189ltr. (6.64cu.ft.)
L8-1755	1110mm	1755mm	700mm	240kg	284ltr. (10.03cu.ft.)

MODEL	Description	Price	MODEL	Description	Price
L8-1320	Stainless	ORDER £2445	L8-1755	Stainless	ORDER £2885

CHILLED STORAGE

GM Range WH

Solid Lid Chest Freezer

Features and Benefits

- * Fitted Handle with Lock
- * Defrost Drain Fitted
- * Inner Liner of Hammered Aluminium
- * Mains Indicator Light
- * Fitted Castors
- * Adjustable Temperature
- * No Internal Light

Technical Specifications

Temperature Range . . . -18/-22°C

Refrigerant R134A

Type of Defrost Manual

Number of Baskets

GM400/500/600 . . . 2

Exterior Finish White

Interior Finish Aluminium

Power Required 13 Amp Supply

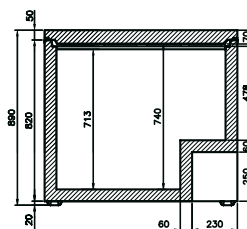

Dimensions	Height:	Width:	Depth:	Weight:	Capacity:
GM400	895mm	1280mm	685mm	61kg385ltr. (13.6cu.ft.)
GM500	895mm	1500mm	685mm	69kg463ltr. (16.3cu.ft.)
GM600	895mm	1800mm	685mm	76kg567ltr. (20.0cu.ft.)

MODEL	Description	Price	MODEL	Description	Price
GM400	White	£460	GM600	White	£579
GM500	White	£526			

GM Range SS

Solid Lid Chest Freezer

Features and Benefits

- * Fitted Handle with Lock
- * Defrost Drain Fitted
- * Inner Liner of Hammered Aluminium
- * Mains Indicator Light
- * Fitted Castors
- * Stainless Steel Lid
- * Adjustable Temperature
- * No Internal Light

Technical Specifications

Temperature Range . . . -18/-22°C

Refrigerant R134A

Type of Defrost Manual

Number of Baskets

GM400/500/600 . . . 2

Exterior Finish White/Stainless

Interior Finish Aluminium

Power Required 13 Amp Supply

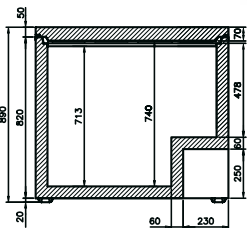

Dimensions	Height:	Width:	Depth:	Weight:	Capacity:
GM400S	895mm	1280mm	685mm	61kg	385ltr. (13.6cu.ft.)
GM500S	895mm	1500mm	685mm	69kg	463ltr. (16.3cu.ft.)
GM600S	895mm	1800mm	685mm	76kg	567ltr. (20.0cu.ft.)

MODEL	Description	Price	MODEL	Description	Price
GM400S	Stainless Steel Lid	£518	GM600S	Stainless Steel Lid	£654
GM500S	Stainless Steel Lid	£582			

LHF Range

Solid Lid Chest Freezer

Features and Benefits

- * Fitted Handle with Lock
- * ISO9001 Quality Controlled Manufacturer
- * 2 Baskets supplied (all models)
- * Defrost Drain Fitted
- * Inner Liner of Hammered Aluminium
- * Mains Indicator Light
- * No Interior Light
- * Adjustable Temperature

Technical Specifications

Temperature Range . . . -18/-22°C
Refrigerant R134A
Type of Defrost Manual
Number of Baskets
LHF400/500/600 . . . 2
Exterior Finish White
Interior Finish Aluminium
Power Required 13 Amp Supply



LHF 540



LHF 620



Depth without handle or hinges = 665mm

Dimensions	Height:	Width:	Depth incs Handles & Hinges:	Weight:	Capacity:
External					
LHF 460	860mm	1300mm	730mm	68kg	447ltr. (15.8cu.ft.)
LHF 540	860mm	1500mm	730mm	72kg	527ltr. (18.6cu.ft.)
LHF 620	860mm	1700mm	730mm	82kg	607ltr. (21.4cu.ft.)
Internal					Max No. of Baskets
LHF 460	715mm	1186mm	536mm		4
LHF 540	715mm	1386mm	536mm		5
LHF 620	715mm	1586mm	536mm		5

MODEL	Description	Price	MODEL	Description	Price
LHF 460	White	£469	LHF 620	White	£583
LHF 540	White	£536			

FROZEN STORAGE

LHF Range

Solid Lid Chest Freezer

Features and Benefits

- * Fitted Handle with Lock
- * ISO9001 Quality Controlled Manufacturer
- * Defrost Drain Fitted
- * Inner Liner of Hammered Aluminium
- * Mains Indicator Light
- * Stainless Steel Lid
- * No Interior Light
- * Adjustable Temperature

Technical Specifications

Temperature Range . . . -18/-22°C
Refrigerant R134A
Type of Defrost Manual
Number of Baskets
LHF400SS/500SS/600SS 2
Exterior Finish White
Interior Finish Aluminium
Power Required 13 Amp Supply



LHF 540 SS



Depth without handle or hinges = 665mm

Dimensions	Height:	Width:	Depth incs Handles & Hinges:	Weight:	Capacity:
External					
LHF 460 SS	860mm	1300mm	730mm	68kg	447ltr. (15.8cu.ft.)
LHF 540 SS	860mm	1500mm	730mm	72kg	527ltr. (18.6cu.ft.)
LHF 620 SS	860mm	1700mm	730mm	82kg	607ltr. (21.4cu.ft.)
Internal					
LHF 460 SS	715mm	1186mm	536mm	Max No. of Baskets	
LHF 540 SS	715mm	1386mm	536mm	4	
LHF 620 SS	715mm	1586mm	536mm	5	

MODEL	Description	Price	MODEL	Description	Price
LHF 460 SS	Stainless Steel	£531	LHF 620 SS	Stainless Steel	£662
LHF 540 SS	Stainless Steel	£594			

XLE Range

Super Low Energy Chest Freezer



Features and Benefits

- * 100mm Insulation
- * A+ Energy Rating
- * Low Running Costs
- * Defrost Drain
- * Mains Indicator Light
- * Temperature Warning Light
- * Hammered Aluminium Liner
- * Lock
- * Adjustable Temperature
- * Internal Light

Technical Specifications

Temperature Range . -18/-22°C
Refrigerant R600
Type of Defrost Manual
Exterior Finish White
Interior Finish Aluminium
Power Required 13 Amp Supply
Energy Consumption @ -18°C
XLE30 0.46kwh/24hr
XLE41 0.57kwh/24hr
XLE51 0.63kwh/24hr



Dimensions	Height:	Width:	Depth:	Weight:	Capacity:
External					
XLE30	860mm	1050mm	730mm	55kg	258ltr. (9.1cu.ft.)
XLE41	860mm	1500mm	730mm	67kg	360ltr. (12.7cu.ft.)
XLE51	860mm	1700mm	730mm	77kg	418ltr. (14.8cu.ft.)
Internal					
XLE30	662mm	1124mm	474mm	2	
XLE41	650mm	1300mm	450mm	4	
XLE51	650mm	1500mm	450mm	4	

MODEL	Description	Price	MODEL	Description	Price
XLE30	White	£642	XLE51	White	£811
XLE41	White	£746			

LT Range

Low Temperature Chest Freezer

Features and Benefits

- * Electronically Controlled
- * Lock Fitted
- * Super Low Temperature to -45°C
- * Inner Liner of Hammered Aluminium
- * ISO9001 Quality Controlled Manufacture
- * 100mm Insulation
- * Digital Temperature Display
- * Temperature Alarm (Visual Only)
- * No Interior Light

Technical Specifications

Temperature Range . -25°C/-45°C
Refrigerant R404A
Type of Defrost Manual
No. of Baskets supplied
11LT 1
21LT 1
31LT 1
41LT 3
51LT 3
Exterior Finish White
Interior Finish Aluminium
Power Required 13 Amp Supply



Dimensions	Height:	Width:	Depth:	Weight:	Capacity:
External					
EL11LT	860mm	720mm	730mm	46kg	136ltr. (4.8cu.ft.)
EL21LT	860mm	1050mm	730mm	58kg	237ltr. (8.4cu.ft.)
EL31LT	860mm	1300mm	730mm	68kg	314ltr. (11.1cu.ft.)
EL41LT	860mm	1500mm	730mm	82kg	375ltr. (13.3cu.ft.)
EL51LT	860mm	1700mm	730mm	90kg	438ltr. (15.47cu.ft.)
Internal					
EL11LT	660mm	520mm	450mm	1	
EL21LT	660mm	850mm	450mm	2	
EL31LT	660mm	1100mm	450mm	3	
EL41LT	660mm	1300mm	450mm	4	
EL51LT	660mm	1504mm	450mm	4	

MODEL	Description	Price	MODEL	Description	Price
EL11LT	White	£712	EL41LT	White	£954
EL21LT	White	£804	EL51LT	White	£1147
EL31LT	White	£918			

FROZEN STORAGE

EL Range

Solid Lid Chest Freezers



EL45



EL12

Stainless Steel lid version



EL61 SS

Features and Benefits

- * Fitted Handle with Lock (except EL12)
- * ISO9001 Quality Controlled Manufacture
- * 60mm Insulation
- * Defrost Drain Fitted
- * Inner Liner of Hammered Aluminium
- * Stainless Steel Lid Option
- * Castors (Optional Extra)
- * Adjustable Temperature

Technical Specifications

Temperature Range . . . -18/-22°C

Refrigerant R134A

Type of Defrost R134A

No. of Baskets supplied

EL12, EL22 1

EL35, EL45 2

EL53, EL61, EL71 3

Exterior Finish White (Stainless Steel lid option)

Interior Finish Aluminium

Power Required 13 Amp Supply



Dimensions	Height:	Width:	Depth:	Weight:	Capacity:
External					
EL12	860mm	550mm	600mm	38kg	110ltr. (3.9cu.ft.)
EL22	860mm	720mm	730mm	46kg	215ltr. (7.6cu.ft.)
EL35	860mm	1050mm	730mm	58kg	347ltr. (12.3cu.ft.)
EL45	860mm	1300mm	730mm	68kg	447ltr. (15.8cu.ft.)
EL53	860mm	1500mm	730mm	72kg	527ltr. (18.6cu.ft.)
EL61	860mm	1700mm	730mm	82kg	607ltr. (21.4cu.ft.)
EL71	903mm	1804mm	770mm	90kg	705ltr. (24.9cu.ft.)
Internal					
EL12	715mm	410mm	410mm	1	
EL22	715mm	606mm	536mm	2	
EL35	715mm	936mm	536mm	3	
EL45	715mm	1186mm	536mm	4	
EL53	715mm	1386mm	536mm	5	
EL61	715mm	1586mm	536mm	5	
EL71	740mm	1686mm	570mm	6	
					Max No of Baskets

MODEL	Description	Price	MODEL	Description	Price
EL12	White	£374	EL22SS	Stainless Steel lid	£499
EL22	White	£459	EL35SS	Stainless Steel lid	£589
EL35	White	£529	EL45SS	Stainless Steel lid	£636
EL45	White	£551	EL53SS	Stainless Steel lid	£689
EL53	White	£596	EL61SS	Stainless Steel lid	£793
EL61	White	£647	EL71SS	Stainless Steel lid	£999
EL71	White	£941			

UF Range

Undercounter Freezer

Features and Benefits

- * Static Cooled
- * Lock Fitted
- * Digital Temperature Display
- * Static Shelves
- * Stainless Steel or White Exterior
- * Matching Chiller - See Page 110
- * Adjustable Feet

Technical Specifications

Temperature Range . . . -18/-22°C
Refrigerant R404A
Type of Defrost Manual
No. of Shelves 2 Static
 (3 Baskets)
Exterior Finish White or
 Stainless Steel
Interior Finish White
Power Required 13 Amp Supply



UF150



UF150 SS



3 Baskets Supplied as Standard

Dimensions	Height:	Width:	Depth:	Weight:	Capacity:
External					
UF150	820mm	600mm	600mm	38kg	146ltr. (5.15cu.ft.)
UF150 SS	820mm	600mm	600mm	41kg	146ltr. (5.15cu.ft.)
Internal					
UF150	685mm	515mm	415mm		
UF150 SS	685mm	515mm	415mm		

MODEL	Description	Price	MODEL	Description	Price
UF150	White	£498	UF150 SS	Stainless Steel	£581

FROZEN STORAGE



CAF175M

Undercounter Freezer



CAF175M

CAF175MS



Features and Benefits

- * Static Cooled
- * Adjustable Temperature
- * Digital Temperature Display
- * Lock Fitted
- * Replaceable Door Gaskets
- * Reversible Door (Factory Option)
- * Adjustable Feet
- * Stainless Steel Exterior Option
- * Matching Chiller - See Page 111
- * Static Shelves

Technical Specifications

Temperature Range -18/-24°C
Refrigerant R134A
Type of Defrost Manual
No. of Shelves 2
Exterior Finish White or Stainless Steel
Interior Finish White
Power Required 13 Amp Supply

Dimensions	Height:	Width:	Depth:	Weight:	Capacity:
External					
CAF175M	850mm	592mm	650mm	55kg	135ltr. (4.8cu.ft.)
Internal					
CAF175M	675mm	465mm	380mm		

CAF175 Fully automatic freezer - See Page 154

MODEL	Description	Price	MODEL	Description	Price
CAF175M	White	£599	CAF175MS	Stainless	£695

N14 Range

Undercounter Freezer



N14L

NX14L



Features and Benefits

- * Fully Automatic Operation
- * Replaceable Gasket
- * Lock Fitted
- * Fan Assisted Cooling
- * Adjustable Shelving
- * Reversible Door (Factory Option)
- * Adjustable Feet
- * Stainless Steel Exterior Option
- * Static Cooled
- * Digital Temperature Display
- * Interior Switchable Light

Technical Specifications

Temperature Range -18/-24°C
Refrigerant R404A
Type of Defrost Manual
No. of Shelves 2
Exterior Finish White or Stainless Steel
Interior Finish White
Power Required 13 Amp Supply

Dimensions	Height:	Width:	Depth:	Weight:	Capacity:
N14L	840mm	604mm	615mm	53kg	130ltr. (4.6cu.ft.)

MODEL	Description	Price	MODEL	Description	Price
N14L	White	£849	NX14L	Stainless	£941

FROZEN STORAGE

Libra Range

Undercounter Freezer

Features and Benefits

- * Fully Automatic Operation
- * Replaceable Gasket
- * Lock Fitted
- * Digital Temperature Display
- * Fan Assisted Cooling
- * Adjustable Shelving
- * Reversible Door (Factory Option)
- * Adjustable Feet
- * Stainless Steel Exterior Option
- * Refrigerator Option - See Page 111
- * Adjustable Temperature

Technical Specifications

Temperature Range . . . -18/-24°C
Refrigerant R134A
Type of Defrost Hot Gas
No. of Shelves 2
Exterior Finish White or
 Stainless Steel
Interior Finish White
Power Required 13 Amp Supply



CAF 175S



CAF 175

Fully Automatic



Dimensions	Height:	Width:	Depth Inc Handles:	Weight:	Capacity:
External					
CAF175	850mm	592mm	650mm	55kg	135ltr. (4.8cu.ft.)
Internal					
CAF175	675mm	465mm	380mm		

MODEL	Description	Price	MODEL	Description	Price
CAF 175	White	£724	CAF 175S	Stainless	£806

RS30

Upright Freezer

Features and Benefits

- * Low Volume Fan
- * Low Energy Consumption
- * Reversible Door
- * Digital Temperature Display
- * Note: Intended for Light Use Only

Technical Specifications

Temperature Range . . . -18/-22°C
Refrigerant R600
Type of Defrost Manual
No. of Shelves 7
Exterior Finish White
Interior Finish White
Power Required 13 Amp Supply



RS30



Dimensions	Height:	Width:	Depth:	Weight:	Capacity:
External					
RS30	1760mm	594mm	645mm	52kg	230ltr. (8.1cu.ft.)
Internal Dimensions					
RS30	1530mm	435mm	350mm		
Drawers					
Internal					
Main Drawers (6)	145mm	390mm	286mm		
Bottom Drawer (1)	173mm	390mm	185mm		

MODEL	Description	Price
RS30	White	£509

UF1380

Upright Freezer



Features and Benefits

- * Static Cooling
- * Adjustable Feet
- * Easy Clean Interior
- * Digital Temperature Display
- * Chiller Option - See Page 113
- * Adjustable Temperature
- * Door Is Not Reversible

Technical Specifications

Temperature Range -18/-22°C
Refrigerant R134A
Type of Defrost Manual
No. of Shelves 6 Fixed Static
Exterior Finish White
Interior Finish White
Power Required 13 Amp Supply

Dimensions	Height:	Width:	Depth:	Weight:	Capacity:
External	UF1380 1835mm	595mm	600mm	90kg372ltr. (13cu.ft.)
Internal	UF1380 1541mm	448mm	445mm		

MODEL	Description	Price
UF1380	White	£659

A400 Range

Upright Freezer

Features and Benefits

- * Easily Replaceable Door Gasket
- * Lock Fitted
- * Low Energy Consumption
- * Reversible Door (Factory Option)
- * Analogue Temperature Display
- * Full Length Door Handle
- * Refrigerator Option - See Page 114
- * Static Freezing Shelves
- * Castor Base (Optional Extra)
- * Adjustable Temperature

Technical Specifications

- Temperature Range** . . . -18/-25°C
- Refrigerant** R134A
- Type of Defrost** Manual
- No. of Shelves** 6 fixed
- Exterior Finish** White or
Stainless Steel
- Interior Finish** White
- Power Required** 13 Amp Supply

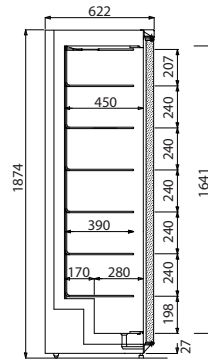

A400N



A400NS

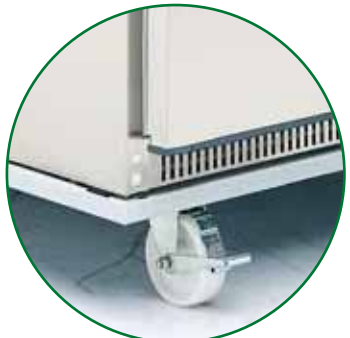

Castor Base Unit Available POA



Dimensions	Height:	Width:	Depth:	Weight:	Capacity:
External					
A400N/NS	1874mm	593mm	622mm	84kg	.343ltr. (12.1cu.ft.)
Internal					
A400N/NS	1641mm	470mm	450mm		

MODEL	Description	Price	MODEL	Description	Price
A400N	White Freezer	£841	A400NS	Stainless Steel Freezer	£1022

A500 Range

Upright Freezer

Features and Benefits

- * Easily Replaceable Door Gasket
- * Lock Fitted
- * Low Energy Consumption
- * Reversible Door (Factory Option)
- * Analogue Temperature Display
- * Full Length Door Handle
- * Refrigerator Option - See Page 115
- * Static Freezing Shelves
- * Castor Base (Optional Extra)
- * Adjustable Temperature

Technical Specifications

Temperature Range -18/-25°C
Refrigerant R134A
Type of Defrost Manual
No. of Shelves 6 fixed
Exterior Finish White or
 Stainless Steel
Interior Finish White
Power Required 13 Amp Supply



A500N

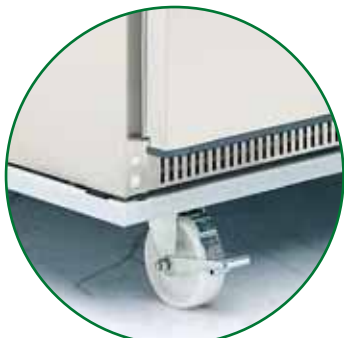
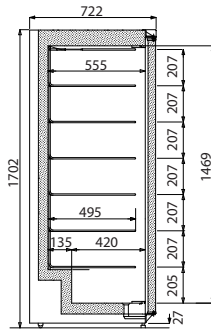

Castor Base Unit Available POA



A500NS



Dimensions	Height:	Width:	Depth:	Weight:	Capacity:
External					
A500N/NS	1702mm	770mm	722mm	94Kg	525ltr. (18.2cu.ft.)
Internal					
A500N/NS	1469mm	650mm	555mm		

MODEL	Description	Price	MODEL	Description	Price
A500N	White Freezer	£967	A500NS	Stainless Steel Freezer	£1182

A600 Range

Upright Freezer

Features and Benefits

- * Replaceable Door Gasket
- * Lock Fitted
- * Low Energy Consumption
- * Reversible Door (Factory Option)
- * Analogue Temperature Display
- * Full Length Door Handle
- * Refrigerator Option - See Page 116
- * Static Freezing Shelves
- * Castor Base (Optional Extra)
- * 2/1 Gastronorm Size - See page 184
- * Adjustable Temperature

Technical Specifications

Temperature Range . . . -18/-25°C

Refrigerant R134A

Type of Defrost Manual

No. of Shelves 6 fixed

Exterior Finish White or
Stainless Steel

Interior Finish White

Power Required 13 Amp Supply

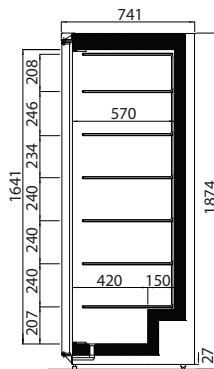

A600N



A600NS



Castor Base Unit
Available POA

Dimensions	Height:	Width:	Depth:	Weight:	Capacity:
External					
A600N/NS	1874mm.	780mm.	741mm	114Kg605ltr. (21.3cu.ft.)
Internal					
A600N/NS	1641mm.	655mm.	570mm		

MODEL	Description	Price	MODEL	Description	Price
A600N	White Freezer	£1004	A600NS	Stainless Steel Freezer	£1220



RF 500

Upright Freezer

Features and Benefits

- * Stainless Steel Exterior
- * Fully Automatic Operation
- * Adjustable Shelving
- * Replaceable Door Gaskets
- * Digital Temperature Display
- * Lock Fitted
- * Chiller Option - See Page 117

Technical Specifications

Temperature Range -18/-24°C
Refrigerant R404A
Type of Defrost Manual
No. of Shelves 3
Exterior Finish Stainless
Interior Finish Stainless
Power Required 13 Amp Supply



RF 500



Dimensions	Height:	Width:	Depth:	Weight:	Capacity:
External					
RF 500	1900mm	680mm	700mm	130kg	429ltr. (15.14cu.ft.)
Internal					
RF 500	1380mm	560mm	553mm		

MODEL	Description	Price
RF 500	White	£1279

RF 710

Gastronorm Upright Freezer

Features and Benefits

- * Stainless Steel Interior & Exterior
- * Fully Automatic Operation
- * Replaceable Door Gasket
- * Electronically Controlled
- * Lock Fitted
- * Digital Temperature Display
- * Fan Assisted Cooling
- * Adjustable Shelving
- * 2/1 Gastronorm Size - See Page 184
- * Chiller Option - See Page 118
- * Interior Light
- * Fitted Castors
- * Adjustable Temperature

Technical Specifications

Temperature Range . . . -18/-22°C
Refrigerant R404
Type of Defrost Electric
No. of Shelves 3
Exterior Finish Stainless Steel
Interior Finish Stainless Steel
Power Required 13 Amp Supply



RF710



Dimensions	Height:	Width:	Depth:	Weight:	Capacity:
External					
RF710	2010mm.	740mm.	860mm	134kg	700ltr. (24.7cu.ft.)
Internal					
RF710	1400mm.	620mm.	700mm		

MODEL	Description	Price
RF710	Stainless Steel	£1444

RF 1420

Gastronorm Upright Freezer



RF1420



Features and Benefits

- * Stainless Steel Interior & Exterior
- * Fully Automatic Operation
- * Replaceable Door Gasket
- * Electronically Controlled
- * Lock Fitted
- * Digital Temperature Display
- * Fan Assisted Cooling
- * Adjustable Shelving
- * 2/1 Gastronorm Size - See Page 184
- * Chiller Options - See Page 119
- * Interior Light
- * Fitted Castors
- * Adjustable Temperature

Technical Specifications

- Temperature Range** -18/-22°C
- Refrigerant** R404
- Type of Defrost** Electric
- No. of Shelves** 6 (3 per side)
- Exterior Finish** Stainless Steel
- Interior Finish** Stainless Steel
- Power Required** 13 Amp Supply

Dimensions	Height:	Width:	Depth:	Weight:	Capacity:
External					
RF1420	2010mm	1480mm	860mm	198kg	1420ltr. (50.1cu.ft.)
Internal					
RF1420	1400mm	1360mm	700mm		

MODEL	Description	Price
RF1420	Stainless Steel	£2163

Capricorn 500

Upright Freezers

Features and Benefits

- * Fitted Castors
- * Lock Fitted
- * Digital Temperature Display
- * Electronically Controlled
- * Replaceable Door Gasket
- * Stainless Steel Interior
- * Auto Defrost
- * Fully Automatic Operation
- * Fan Assisted Cooling
- * Refrigerator Option - See Page 120
- * Matches Depth of PH Counters (p137, p167)
- * Adjustable Temperature

Technical Specifications

Temperature Range . . . -15/-20°C
Refrigerant R404A
Type of Defrost Hot Gas
No. of Shelves 5
Exterior Finish White or Stainless Steel
Interior Finish Stainless Steel
Power Required 13 Amp Supply

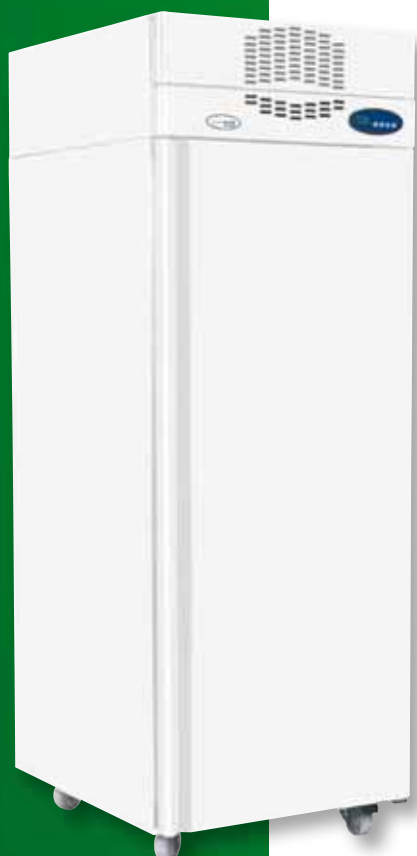

CAF 500W



CAF 500S



N.B. Does Not Accept Gastronorm Trays

Dimensions	Height:	Width:	Depth:	Weight:	Capacity:	
External	CAF 500	2000mm	710mm	700mm	152kg500ltr. (17.6cu.ft.)
Internal	CAF 500	1480mm	590mm	580mm		

MODEL	Description	Price	MODEL	Description	Price
CAF 500W	White	£1518	CAF 500S	Stainless Steel	£1688

Capricorn 1100

Upright Freezers

Features and Benefits

- * Adjustable Shelving
- * Twin Fans
- * Fitted Castors
- * Lock Fitted
- * Digital Temperature Display
- * Electronically Controlled
- * Replaceable Door Gasket
- * Stainless Steel Interior
- * Auto Defrost
- * Fully Automatic Operation
- * Fan Assisted Cooling
- * Refrigerator Option - See Page 121
- * Adjustable Temperature

Technical Specifications

Temperature Range	-15/-20°C
Refrigerant	R404A
Type of Defrost	Hot Gas
No. of Shelves	5 per side
Exterior Finish	White or Stainless Steel
Interior Finish	Stainless Steel
Power Required	13 Amp Supply



CAF 1100S



CAF 1100W



N.B. Does Not Accept Gastronorm Trays

Dimensions	Height:	Width:	Weight:	Depth:	Capacity:
External					
CAF 1100	2000mm	1420mm	700mm	244kg	1100ltr. (38.8cu.ft.)
Internal					
CAF 1100	1480mm	1180mm	580mm		

MODEL	Description	Price	MODEL	Description	Price
CAF 1100W	White	£2106	CAF 1100S	Stainless Steel	£2446

Capricorn 600

Gastronorm Upright Freezers

Features and Benefits

- * Fully Automatic Operation
- * Electronically Controlled
- * Stainless Steel Interior
- * Replaceable Door Gasket
- * Fitted Castors
- * Digital Temperature Display
- * Fan Assisted Cooling
- * Suitable for use in High Ambient Locations
- * Fully Adjustable Shelving
- * Lock Fitted
- * 2/1 Gastronorm Size - See Page 184
- * Refrigerator Option - See Page 122

Technical Specifications

- Temperature Range** . . . -18/-22°C
Refrigerant R404A
Type of Defrost Electric
No. of Shelves 5
Exterior Finish White or
 Stainless Steel
Interior Finish Stainless Steel
Power Required 13 Amp Supply



CAF 600W



CAF 600S



Dimensions	Height:	Width:	Depth:	Weight:	Capacity:
External					
CAF 600	2000mm	710mm	800mm	167kg600ltr. (21.2cu.ft.)
CAF 600S	2000mm	710mm	800mm	167kg600ltr. (21.2cu.ft.)
Internal					
CAF 600	1480mm	590mm	680mm		
CAF 600S	1480mm	590mm	680mm		

MODEL	Description	Price	MODEL	Description	Price
CAF 600W	White	£1582	CAF 600S	Stainless	£1849

Capricorn 1300

Gastronorm Upright Freezer

Features and Benefits

- * Fully Automatic Operation
- * Electronically Controlled
- * Stainless Steel Interior
- * Replaceable Door Gasket/s
- * Fitted Castors
- * Digital Temperature Display
- * Fan Assisted Cooling
- * Suitable for use in High Ambient Locations
- * Adjustable Shelving
- * Lock Fitted
- * Stainless Steel Exterior option available (1300S)
- * 2/1 Gastronorm Size - See Page 184
- * Refrigerator/Meat Cabinet Option - See Page 123
- * Adjustable Temperature

Technical Specifications

Temperature Range	-18/-22°C
Refrigerant	R404A
Type of Defrost	Electric
No. of Shelves	10+5 +intermediates
Exterior Finish	White or Stainless Steel
Interior Finish	Stainless Steel
Power Required	13 Amp Supply



CAF 1300S



CAF 1300W



Glass door option available. See page 101



Dimensions	Height:	Width:	Depth:	Weight:	Capacity:
External					
CAF 1300	2000mm	1420mm	800mm	264kg	1300ltr. (45.7cu.ft.)
CAF 1300S	2000mm	1420mm	800mm	264kg	1300ltr. (45.7cu.ft.)
Internal					
CAF 1300	1480mm	1180mm	680mm		
CAF 1300S	1480mm	1180mm	680mm		

MODEL	Description	Price	MODEL	Description	Price
CAF 1300W	White	£2414	CAF 1300S	Stainless	£2759

CF Range

Gastronorm Freezer Counter

Features and Benefits

- * Stainless Steel Exterior 304 Grade
- * Injected Polyurethane Insulation
- * 1 Shelf per Door
- * Castors
- * Digital Temperature Display
- * Compressor on Indicator
- * Gastronorm Pans Available - Not Supplied - See Page 184
- * 1/1 Gastronorm Size
- * Splashback
- * Chiller Option - See Page 132

Technical Specifications

Temperature Range . . . -18/-22°C
Refrigerant R404A
Type of Defrost Electric
Exterior Finish Stainless Steel
Interior Finish Stainless Steel
Power Required 13 Amp Supply



CF7210



CF7310



Dimensions	Height:	Width:	Depth:	Weight:	Capacity:
CF 7210 2 Door . . .	850mm	1360mm	700mm	103kg265ltr. (9.35cu.ft.)
CF 7310 3 Door . . .	850mm	1795mm	700mm	136kg400ltr. (14.1cu.ft.)
CF 7410 4 Door . . .	850mm	2230mm	700mm	155kg520ltr. (18.4cu.ft.)

MODEL	Description	Price	MODEL	Description	Price
CF 7210	2 Door Stainless Steel	£1431	CF 7410	4 Door Stainless Steel	£1941
CF 7310	3 Door Stainless Steel	£1703			

Scorpio

Gastronorm Freezer Counter



Splashback Factory Options

PH2Z	£105
PH3Z	£152
PH4Z	£166

PH2Z with optional splashback

Dimensions	Height:	Width:	Depth:	Weight:	Capacity:
External					
PH2Z 2 door	850mm	1356mm	700mm	166kg262ltr. (9.2cu.ft.)
PH3Z 3 door	850mm	1834mm	700mm	202kg410ltr. (14.4cu.ft.)
PH4Z 4 door	850mm	2312mm	700mm	242kg560ltr. (19.7cu.ft.)
Internal					
PH2Z	540mm	836mm	530mm		
PH3Z	540mm	1314mm	530mm		
PH4Z	540mm	1792mm	530mm		

MODEL	Description	Price	MODEL	Description	Price
PH2Z 2 door	Stainless	£1912	PH4Z 4 door	Stainless	£2689
PH3Z 3 door	Stainless	£2352			

Features and Benefits

- * Fully Automatic Operation
- * Electronically Controlled
- * Stainless Steel Interior & Exterior
- * Fitted Castors
- * Fan Assisted Cooling
- * Suitable for use in High Ambient Locations
- * Adjustable Shelving
- * Digital Temperature Display
- * Splashbacks (Factory Option)
- * Refrigerator/Meat Temperature Units Option - See Page 136/137
- * 1/1 Gastronorm size - See Page 184

Technical Specifications

Temperature Range	-18/-22°C
Refrigerant	R404A
Type of Defrost	Electric
No. of Shelves	
PH2Z	2
PH3Z	3
PH4Z	4
Exterior Finish	Stainless Steel
Interior Finish	Stainless Steel
Power Required	13 Amp Supply

T1-1845 with optional splashback

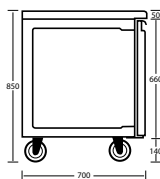

Splashback	Price
T1 1380	£126
T1 1845	£165

Dimensions	Height:	Width:	Depth:	Weight:	Capacity:	No. of Doors:
T1 1380 2 door	850mm	1380mm	700mm	199kg263ltr. (9.2cu.ft.)	2
T1 1845 3 door	850mm	1845mm	700mm	227kg410ltr. (14.4cu.ft.)	3

MODEL	Description	Price	MODEL	Description	Price
T1 1380 2 door	Stainless	£1999	T1 1845 3 door	Stainless	£2649

Features and Benefits

- * Stainless Steel Exterior 304 Grade
- * Injected Polyurethane Insulation
- * 1 Interior Shelf per Door
- * Fitted Castors
- * Hermetic Compressor
- * Digital Temperature Display
- * Compressor on Indicator
- * Gastronorm Pans Available - Not Supplied
- * 1/1 Gastronorm Size - See Page 184
- * Splashback - (Factory Option)
- * Chiller Option - See Page 134/135
- * Adjustable Temperature

Technical Specifications

Temperature Range	-18/-20°C
Refrigerant	R404A
Type of Defrost	Electric
Exterior Finish	Stainless Steel
Interior Finish	Stainless Steel
Power Required	13 Amp Supply
High Ambient	40°C

FROZEN STORAGE

Chillers and Freezers



Features and Benefits

- * Switchable Interior Light
- * Digital Temperature Display
- * Lock Fitted
- * Electronically Controlled
- * Fan Assisted Cooling
- * Fully Automatic Operation
- * Chiller suitable for Fresh Meat
- * Left-hand Hung Doors Available POA
- * Stainless Steel Floor as Standard
- * Suitable for use up to 32°C Ambient
- * Pressure Release Valve Fitted on Freezer Rooms
- * Heated Door Frames
- * 75mm Insulation on all Rooms
- * Integral Ladder Rack Shelving - 4 Tier
- * Deep Shelf 445mm
- * Shallow Shelf 333mm
- * Ladder Rack 1200mm high
- * Coldroom Floors Not Suitable for Trolleys. Floorless Rooms Available POA

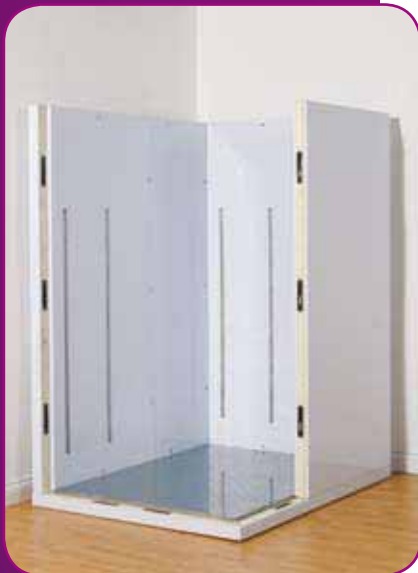

COLD ROOMS

Technical Specifications

Temperature Ranges

Chiller -2/+6°C

Freezer -18/-22°C

Refrigerant R404A

Type of Defrost Hot Gas

Exterior Finish White

Interior Finish White/Stainless

Power Required 20 Amp Supply

* External Height - 2000mm

* Internal Height - 1860mm

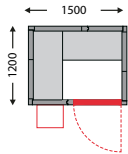

PC1512

Complete Chiller Room **£3534**
 Complete Freezer Room **£3829**

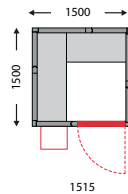

PC1515

Complete Chiller Room **£3822**
 Complete Freezer Room **£4117**

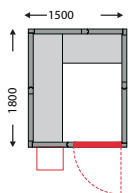

PC1518

Complete Chiller Room **£3925**
 Complete Freezer Room **£4220**

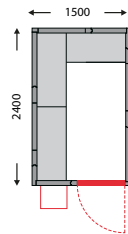

PC1524

Complete Chiller Room **ORDER £4490**
 Complete Freezer Room **ORDER £4785**

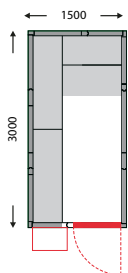

PC1530

Complete Chiller Room **ORDER £4790**
 Complete Freezer Room **ORDER £5234**

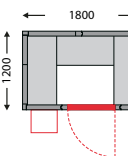

PC1812

Complete Chiller Room **ORDER £3797**
 Complete Freezer Room **ORDER £4092**

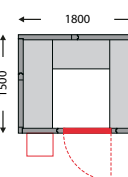

PC1815

Complete Chiller Room **£4101**
 Complete Freezer Room **£4396**

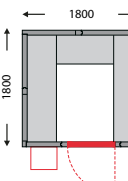

PC1818

Complete Chiller Room **£4203**
 Complete Freezer Room **£4498**



Strip curtain recommended for all rooms to ensure even temperature. POA

More Options Overleaf

Chillers and Freezers



Lockable Door



Interior Door Handle



Four Tier Integral Shelving

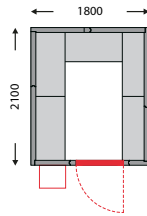

PC1821

Complete Chiller Room	£4539
Complete Freezer Room	£4834

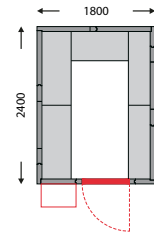

PC1824

Complete Chiller Room	£4818
Complete Freezer Room	£5262

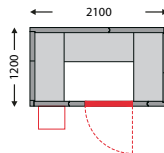

PC2112

Complete Chiller Room	£3935
Complete Freezer Room	£4230

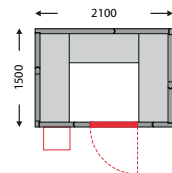

PC2115

Complete Chiller Room	£4239
Complete Freezer Room	£4534

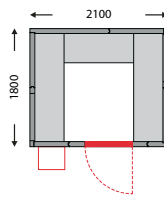

PC2118

Complete Chiller Room	£4419
Complete Freezer Room	£4714

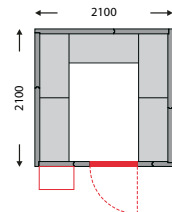

PC2121

Complete Chiller Room	£4800
Complete Freezer Room	£5244

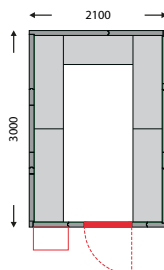

PC2130

Complete Chiller Room	ORDER £5625
Complete Freezer Room	ORDER £5888

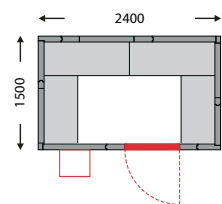

PC2415

Complete Chiller Room	£4622
Complete Freezer Room	£4917

Features and Benefits

- * Switchable Interior Light
- * Digital Temperature Display
- * Lock Fitted
- * Electronically Controlled
- * Fan Assisted Cooling
- * Fully Automatic Operation
- * Chiller suitable for Fresh Meat
- * Left-hand Hung Doors Available POA
- * Stainless Steel Floor as Standard
- * Suitable for use up to 32°C Ambient
- * Pressure Release Valve Fitted on Freezer Rooms
- * Heated Door Frames
- * 75mm Insulation on all Rooms
- * Integral Ladder Rack Shelving - 4 Tier
- * Deep Shelf 445mm
- * Shallow Shelf 333mm
- * Ladder Rack 1200mm high
- * Coldroom Floors Not Suitable for Trolleys. Floorless Rooms Available POA

Technical Specifications

Temperature Ranges



Chiller -2/+6°C
Freezer -18/-22°C

Refrigerant R404A
Type of Defrost Hot Gas
Exterior Finish White
Interior Finish White/Stainless
Power Required 20 Amp Supply

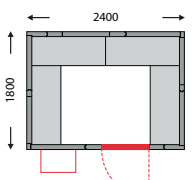
- * External Height - 2000mm
- * Internal Height - 1860mm



PC2418

Complete Chiller Room		£4816
Complete Freezer Room		£5260

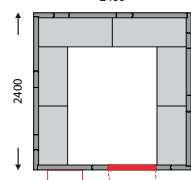

PC2424

Complete Chiller Room		£5540
Complete Freezer Room		£5803

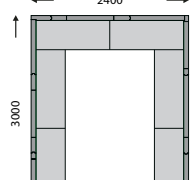

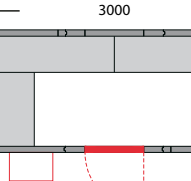

PC2430

Complete Chiller Room		£6348
Complete Freezer Room		£6611



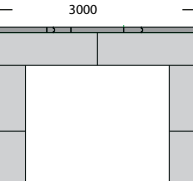

PC3015

Complete Chiller Room		£4887
Complete Freezer Room		£5331



PC3024

Complete Chiller Room		£6314
Complete Freezer Room		£6577



Criocabin

Modular Cold Rooms



Features and Benefits

- * Interior Light
- * Digital Temperature Display (Integral version only)
- * Lock Fitted
- * Aluminium Shelving Included as Standard - 3 Tier
- * Electronically Controlled Fan Assisted Cooling
- * Fully Automatic Operation
- * Remote Options
- * Models suitable for General Purpose, Meat (CE) or Frozen Goods (FE)
- * Left-hand Hung Doors Available POA
- * Stainless Steel Floor as Standard
- * Suitable for use up to 32°C Ambient
- * Door Switch for Fan Fitted as Standard
- * Pressure Release Valve Fitted on Freezer Rooms
- * Coldroom Floors Not Suitable for Trolleys. Floorless Rooms Available POA

Technical Specifications

Temperature Ranges

General Purpose /

Fresh Meat -2/+6°C

Freezer -18/-20°C

Refrigerant R404

Type of Defrost Hot Gas

Exterior Finish White

Interior Finish White

Power Required 20 Amp Supply



Strip curtain recommended for all rooms to ensure even temperature. POA

Easy Fit Monoblock



Simple Modular Construction



Monoblock and Pressure Release Valve



Lockable Door (with emergency opening)



Non Slip Stainless Steel Floor



Freestanding Aluminium Shelving

Features and Benefits

- * External Height - 2170mm
- * Internal Height - 2030mm
- * Insulation Thickness - 70mm
- * Clear Door Opening - 800mm x 1900mm
- * Right Hand Hinged Door (Left Hand Hinge Optional POA)
- * 3 Tier Shelving supplied as Standard
- * Shelving = 460mm deep
- * Suitable For Fresh Meat -2/+2°C



Chiller Rooms

For freezer rooms see pages 176-177

Remote Systems are supplied with 2.5m pre-charged lines.
10m available at additional cost of £325.00

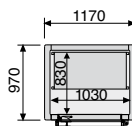

CE1012

Complete Integral room	£3542
Complete Remote room	£5043 <small>ORDER</small>
Room only	£1780
Shelving only	£208
Integral ref. unit only	£1554
Remote ref. unit only	£3055 <small>ORDER</small>

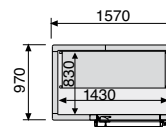

CE1016

Complete Integral room	£3794
Complete Remote room	£5295 <small>ORDER</small>
Room only	£1996
Shelving only	£244
Integral ref. unit only	£1554
Remote ref. unit only	£3055 <small>ORDER</small>

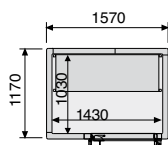

CE1216

Complete Integral room	£3877
Complete Remote room	£5378 <small>ORDER</small>
Room only	£2078
Shelving only	£245
Integral ref. unit only	£1554
Remote ref. unit only	£3055 <small>ORDER</small>

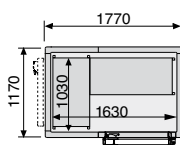

CE1218

Complete Integral room	£4116
Complete Remote room	£5617 <small>ORDER</small>
Room only	£2173
Shelving only	£389
Integral ref. unit only	£1554
Remote ref. unit only	£3055 <small>ORDER</small>

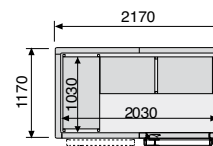

CE1222

Complete Integral room	£4289
Complete Remote room	£5790 <small>ORDER</small>
Room only	£2317
Shelving only	£418
Integral ref. unit only	£1554
Remote ref. unit only	£3055 <small>ORDER</small>

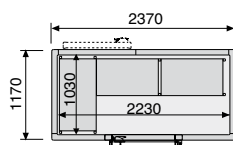

CE1224

Complete Integral room	£4447
Complete Remote room	£5971 <small>ORDER</small>
Room only	£2399
Shelving only	£494
Integral ref. unit only	£1554
Remote ref. unit only	£3078 <small>ORDER</small>

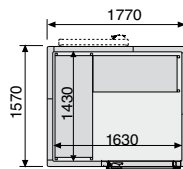

CE1618

Complete Integral room	£4507
Complete Remote room	£6031 <small>ORDER</small>
Room only	£2538
Shelving only	£415
Integral ref. unit only	£1554
Remote ref. unit only	£3078 <small>ORDER</small>

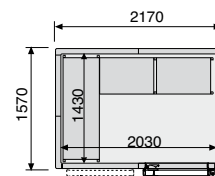

CE1622

Complete Integral room	£4858
Complete Remote room	£6396 <small>ORDER</small>
Room only	£2753
Shelving only	£517
Integral ref. unit only	£1588
Remote ref. unit only	£3126 <small>ORDER</small>

Remote Systems are supplied with 2.5m pre-charged lines.
10m available at additional cost of £325.00

Chiller Rooms

For freezer rooms see pages 176-177

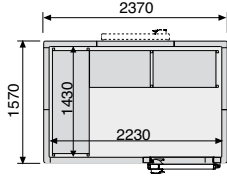

CE1624

Complete Integral room	£5078
Complete Remote room	£6520 <small>ORDER</small>
Room only	£2852
Shelving only	£542
Integral ref. unit only	£1684
Remote ref. unit only	£3126 <small>ORDER</small>

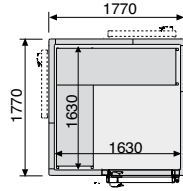

CE1818

Complete Integral room	£4723
Complete Remote room	£6213 <small>ORDER</small>
Room only	£2698
Shelving only	£437
Integral ref. unit only	£1588
Remote ref. unit only	£3078 <small>ORDER</small>

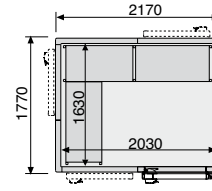

CE1822

Complete Integral room	£5118
Complete Remote room	£6560 <small>ORDER</small>
Room only	£2897
Shelving only	£537
Integral ref. unit only	£1684
Remote ref. unit only	£3126 <small>ORDER</small>

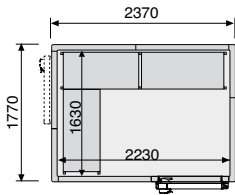

CE1824

Complete Integral room	£5296
Complete Remote room	£7057 <small>ORDER</small>
Room only	£3064
Shelving only	£548
Integral ref. unit only	£1684
Remote ref. unit only	£3445 <small>ORDER</small>

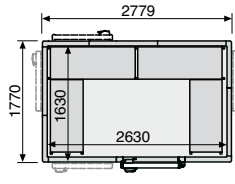

CE1828

Complete Integral room	£6021
Complete Remote room	£7736 <small>ORDER</small>
Room only	£3527
Shelving only	£764
Integral ref. unit only	£1730
Remote ref. unit only	£3445 <small>ORDER</small>

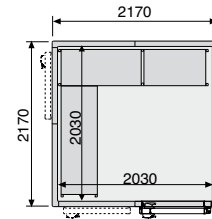

CE2222

Complete Integral room	£5489
Complete Remote room	£7250 <small>ORDER</small>
Room only	£3168
Shelving only	£637
Integral ref. unit only	£1684
Remote ref. unit only	£3445 <small>ORDER</small>

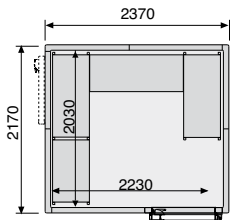

CE2224

Complete Integral room	£5938
Complete Remote room	£7653 <small>ORDER</small>
Room only	£3479
Shelving only	£729
Integral ref. unit only	£1730
Remote ref. unit only	£3445 <small>ORDER</small>

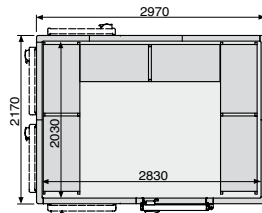

CE2230

Complete Integral room	£6865
Complete Remote room	£8423 <small>ORDER</small>
Room only	£3792
Shelving only	£986
Integral ref. unit only	£2087
Remote ref. unit only	£3645 <small>ORDER</small>

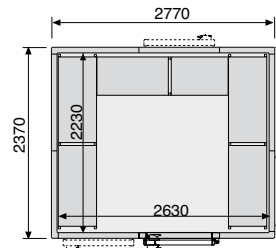

CE2428

Complete Integral room	£6750
Complete Remote room	£8308 <small>ORDER</small>
Room only	£3668
Shelving only	£995
Integral ref. unit only	£2087
Remote ref. unit only	£3645 <small>ORDER</small>

Freezer Rooms

For chiller rooms see pages 174-175

Remote Systems are supplied with 2.5m pre-charged lines.
10m available at additional cost of £325.00

Features and Benefits

- * External Height - 2230mm
- * Internal Height - 2030mm
- * Insulation Thickness - 100mm
- * Clear Door Opening - 800mm x 1900mm
- * Right Hand Hinged Door (Left Hand Hinge Optional POA)
- * 3 Tier Shelving supplied as Standard
- * Shelving = 460mm deep



3 Tier Shelving supplied as standard

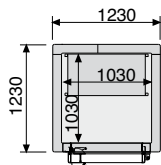

FE1212

Complete Integral room	£4093
Complete Remote room	ORDER £5489
Room only	£2105
Shelving only	£208
Integral ref. unit only	£1780
Remote ref. unit only	ORDER £3176

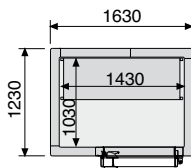

FE1216

Complete Integral room	£4320
Complete Remote room	ORDER £5716
Room only	£2295
Shelving only	£245
Integral ref. unit only	£1780
Remote ref. unit only	ORDER £3176

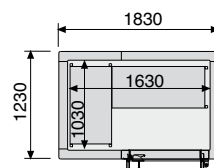

FE1218

Complete Integral room	£4548
Complete Remote room	ORDER £6177
Room only	£2379
Shelving only	£389
Integral ref. unit only	£1780
Remote ref. unit only	ORDER £3409

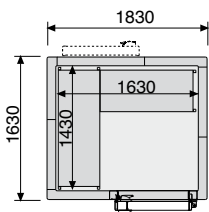

FE1618

Complete Integral room	£5118
Complete Remote room	ORDER £6623
Room only	£2799
Shelving only	£415
Integral ref. unit only	£1904
Remote ref. unit only	ORDER £3409

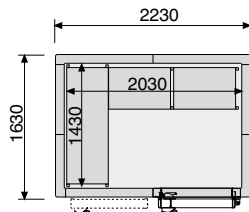

FE1622

Complete Integral room	£5449
Complete Remote room	ORDER £6925
Room only	£2999
Shelving only	£517
Integral ref. unit only	£1933
Remote ref. unit only	ORDER £3409

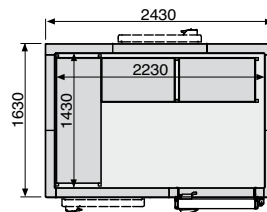

FE1624

Complete Integral room	£5914
Complete Remote room	ORDER £7489
Room only	£3439
Shelving only	£542
Integral ref. unit only	£1933
Remote ref. unit only	ORDER £3508

Remote Systems are supplied with 2.5m pre-charged lines.
10m available at additional cost of £325.00

Freezer Rooms

For chiller rooms see pages 174-175



3 Tier Shelving supplied as standard

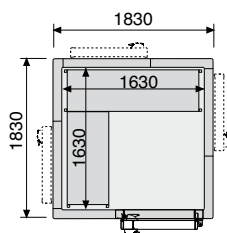

FE1818

Complete Integral room	£5304
Complete Remote room	ORDER £6809
Room only	£2963
Shelving only	£437
Integral ref. unit only	£1904
Remote ref. unit only	ORDER £3409

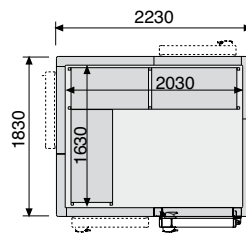

FE1822

Complete Integral room	£5638
Complete Remote room	ORDER £7213
Room only	£3168
Shelving only	£537
Integral ref. unit only	£1933
Remote ref. unit only	ORDER £3508

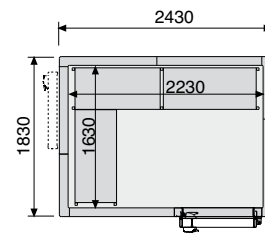

FE1824

Complete Integral room	£5750
Complete Remote room	ORDER £7325
Room only	£3269
Shelving only	£548
Integral ref. unit only	£1933
Remote ref. unit only	ORDER £3508

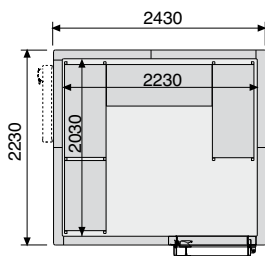

FE2224

Complete Integral room	£6368
Complete Remote room	ORDER £7811
Room only	£3574
Shelving only	£729
Integral ref. unit only	£2065
Remote ref. unit only	ORDER £3508

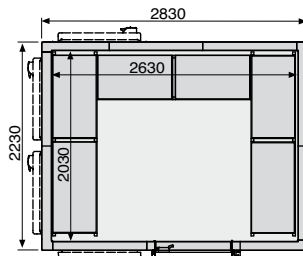

FE2228

Complete Integral room	£7182
Complete Remote room	ORDER £9526
Room only	£4139
Shelving only	£978
Integral ref. unit only	£2065
Remote ref. unit only	ORDER £4409

Split Systems

For Cold Rooms



Standard Features

- * Hermetic Compressor
- * Unit connection terminal board
- * Low noise level fans
- * All single phase 230V - 50Hz



All Split Systems are to order

Model No	Capacity M3	Split System to suit	List Price	Temp Range
CE1012	1.7	FS07TN	£3055	-2/+4°C
CE1016	2.4	FS07TN	£3055	-2/+4°C
CE1216	3.0	FS07TN	£3055	-2/+4°C
CE1218	3.4	FS07TN	£3055	-2/+4°C
CE1222	4.2	FS07TN	£3055	-2/+4°C
CE1224	4.7	FS09TN	£3078	-2/+4°C
CE1618	4.7	FS09TN	£3078	-2/+4°C
CE1818	5.4	FS09TN	£3078	-2/+4°C
CE1622	5.9	FS11TN	£3126	-2/+4°C
CE1624	6.5	FS11TN	£3126	-2/+4°C
CE1822	6.7	FS11TN	£3126	-2/+4°C
CE1824	7.4	FS16TN	£3445	-2/+4°C
CE1828	8.7	FS16TN	£3445	-2/+4°C
CE2222	8.4	FS16TN	£3445	-2/+4°C
CE2224	9.2	FS16TN	£3445	-2/+4°C
CE2230	11.7	FS19TN	£3645	-2/+4°C
CE2428	11.9	FS19TN	£3645	-2/+4°C

Model No	Capacity M3	Split System to suit	List Price	Temp Range
FE1212	2.0	FS03BT	£3176	-18/-22°C
FE1216	2.6	FS03BT	£3176	-18/-22°C
FE1218	3.2	FS06BT	£3409	-18/-22°C
FE1618	4.2	FS06BT	£3409	-18/-22°C
FE1818	5.0	FS06BT	£3409	-18/-22°C
FE1622	5.2	FS06BT	£3409	-18/-22°C
FE1624	6.5	FS09BT	£3508	-18/-22°C
FE1822	6.1	FS09BT	£3508	-18/-22°C
FE1824	7.1	FS09BT	£3508	-18/-22°C
FE2224	8.4	FS09BT	£3508	-18/-22°C
FE2228	10.8	FS15BT	£4409	-18/-22°C

FE2228 Requires 3 Phase Supply

Suitable for use in ambients of up 35°C
Standard supply is with 2.5m pre-charged lines,
10m available at additional cost of £325.00

Coldroom Installations

Details below are for installation of packaged integral Coldrooms by Interlewin

CRIOCABIN Modular Cold Rooms are supplied as quick to assemble packs



Installation

Subject to:

- (a) Suitable single phase 20 amp fixed isolator to be provided by clients electrical contractor.
- (b) Flat prepared floor
- (c) Isolator to be within 1m of coldroom equipment.
- (d) Suitable ventilation if required
- (e) Suitable clear access to site for delivery and installation.
- (f) Prices assume normal working day Monday to Friday 0830 to 1700 hours.
- (g) Rooms are not suitable for outdoor installation.
- (h) Any subsequent visits to finish coldroom installation due to site delays or non site / incorrect site survey will incur additional costs.

Site Survey

A site survey option is available and recommended upon request for UK Mainland.

Multiple Installations would be price on application

Remote installations subject to site survey and quotation

Description	Price	Description	Price
Chiller / Freezer Models (Integral only)	£725	Site Survey	£140

Prices apply only to units listed in this Catalogue



Features and Benefits

- * Adjustable feet as standard
- * Flexible solutions of layout and design
- * High strength extruded anodised aluminium construction
- * Suitable for operation down to -30°C
- * Easily removable shelf inserts for cleaning (dishwasher safe)
- * Additional storage space and improved access is gained through the cleverly designed internal corner
- * Complies with NF food hygiene standards
- * Quick and easy installation
- * Adjustable shelf position with 10 preset at every 150mm centres
- * Optional fitted castors, 2 lockable as standard
- * Maximum load per section - 600kg
- * Maximum load per shelf - 120kg
- * Standard range supplied with copolymer inserts
- * Aluminium inserts available. POA



Height - 1685mm
Depth - 460mm



*Note, to calculate corners, deduct £20.00 for 3 tier and £8.00 for 4 tier from the cost price

Length	3 tier	4 tier
657mm	£275	£304
777mm	£285	£319
897mm	£295	£339
957mm	£304	£362
1077mm	£311	£375
1197mm	£325	£401
1317mm	£343	£423
1497mm	£361	£462
1617mm	£415	£502
1737mm	£445	£539
1827mm	£526	£625
1887mm	£538	£641
1947mm	£536	£638
2007mm	£548	£654
2067mm	£554	£663
2127mm	£559	£667

Length	3 tier	4 tier
2187mm	£576	£695
2247mm	£586	£704
2367mm	£601	£724
2427mm	£610	£739
2487mm	£619	£749
2547mm	£622	£755
2607mm	£646	£779
2667mm	£642	£777
2787mm	£667	£809
2907mm	£697	£856
2967mm	£684	£838
3027mm	£729	£889
3087mm	£727	£886
3207mm	£747	£917
3327mm	£781	£965
3447mm	£801	£995

* All Fermod shelving options available P.O.A.

Standard range supplied with copolymer inserts
aluminium inserts available as shown P.O.A.



Fermod
Shelving Systems



COLD ROOMS