

GRAPHIC DISPLAY

the display collection



**JOHN
ELLIS**

DISPLAY EXHIBITION
& SHOP EQUIPMENT

Accessories can make an enormous difference to the power of your presentation. Create highly attractive hard-working projects

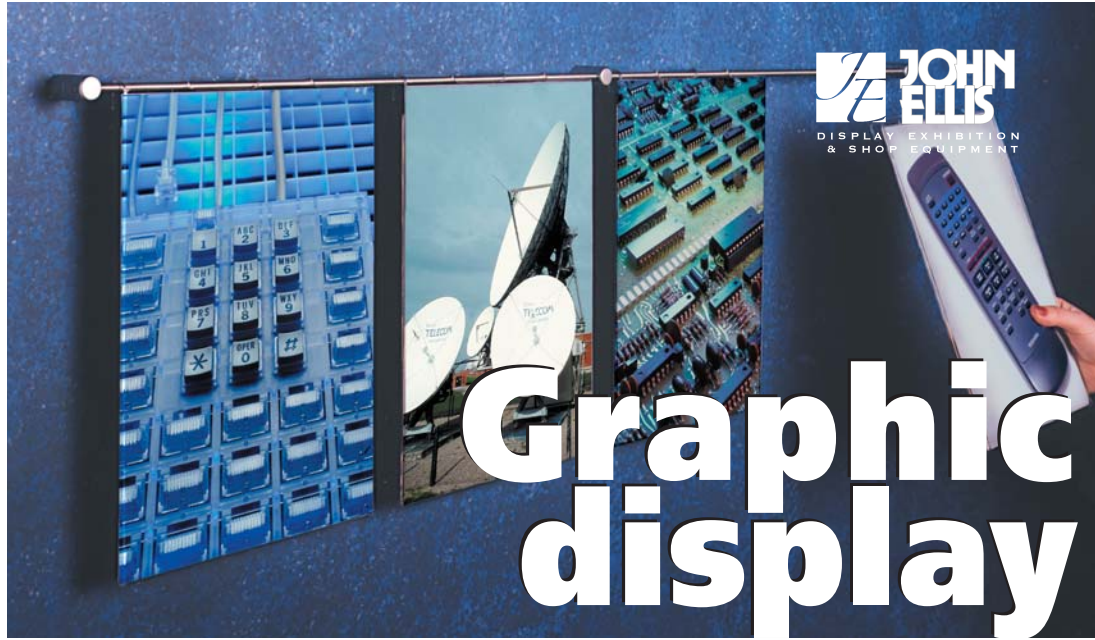

Graphic display



Your choice of finishes & material

More than just clear acrylic... be adventurous and turn a simple design into something spectacular...

- Imagery...**
Screen printing
Create high quality text and logo images.
- Vinyl lettering**
An inexpensive option, ideal for simple lettering.

- Acrylics...**
Non-reflective acrylic - used to increase visibility in sunny windows or to reduce the glare from spot lighting.
Silicone - green edge, looks like glass.
Sandblasted effect - looks like sandblasted glass and does not show dust. Creates impressive screens and background panels.
Coloured acrylic - solid colours create ideal background panels.



Acrylic pockets & poster holders

A wide range of pocket types and sizes are available to suit any display requirement. Shown here are just some of the options available - if you want a special size or shape, please call to discuss your requirements.

Easy access pockets

Portrait and landscape pockets in clear acrylic, available in a wide range of sizes.

- designed to be used with cable/rod systems or wall mounted supports (WM09, WM05-13 with WMS-2)



Jumbo pockets

Double sided acrylic pocket designed to take very large posters. Made to order - please call for details.

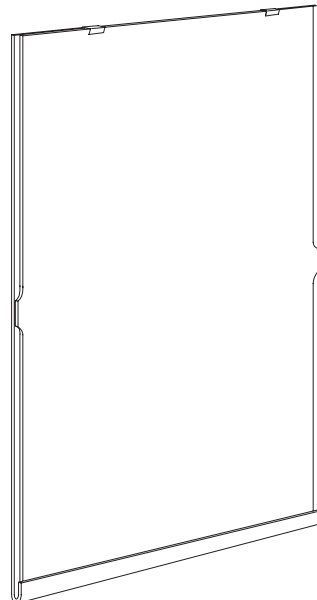

'C' shaped pockets

A poster display that has a decorative back panel which can be screen printed with logos or text. Back panel can be supplied straight or with decorative 'ragged' edge. Made to order only - please call.

Easy access pockets

- portrait and landscape pockets in clear acrylic with polished edges
- available in a wide range of sizes

Portrait pockets

- A2, A1 and A0 are supplied with top clip as standard
- Sizes A5 and A4 are 2mm thick acrylic, all others are 3mm thick

Item Code:	Size:	1.5mm & 3mm Cable/Rod centre:	6mm Rod centre:	10mm Rod centre:	Price £:
MA5PW	A5	182mm	186mm	190mm	3.50
MA4PW	A4	244mm	248mm	252mm	4.90
MA3PW	A3	331mm	335mm	339mm	11.25
MA2PW	A2	454mm	458mm	462mm	21.00
MA1PW	A1	628mm	632mm	636mm	35.85
MA0PW	A0 (2 part pocket)	875mm	879mm	883mm	90.00
M5070PW	500mm x 700mm	534mm	538mm	542mm	30.75
A2030PW	Crown (20" x 30")	542mm	546mm	550mm	33.00
A3040PW	Double Crown (Quad) (30" x 40")	796mm	800mm	804mm	73.75

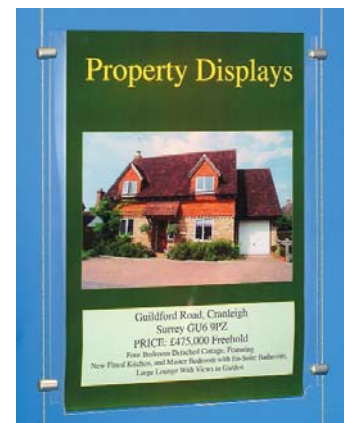

Portrait

Landscape

Landscape pockets

- A2 and A1 are supplied with top clip as standard
- Sizes A5, A4 and A3 are 2mm thick acrylic, all others are 3mm thick

Item Code:	Size:	1.5mm & 3mm Cable/Rod centre:	6mm Rod centre:	10mm Rod centre:	Price £:
MA5LW	A5	244mm	248mm	252mm	3.50
MA4LW	A4	331mm	335mm	339mm	4.90
MA3LW	A3	454mm	458mm	462mm	11.25
MA2LW	A2	628mm	632mm	636mm	21.00
MA1LW	A1	875mm	879mm	883mm	35.85

Spare top clips

- for use with landscape and portrait easy access pockets



Item Code:	Price £:
MRC	0.75

Double and treble width pockets

- double and treble width A4 portrait pockets in 2mm thick clear acrylic

Item Code:	Size:	1.5mm & 3mm Cable/Rod centre:	6mm Rod centre:	10mm Rod centre:	Price £:
M2A4PW	A4 x 2 pockets	466mm	470mm	474mm	10.50
M3A4PW	A4 x 3 pockets	688mm	692mm	696mm	14.00

- A3 landscape pocket to be used with M2A4PW above

Item Code:	Size:	1.5mm & 3mm Cable/Rod centre:	6mm Rod centre:	10mm Rod centre:	Price £:
MA3LW-456	A3	466mm	470mm	474mm	11.25

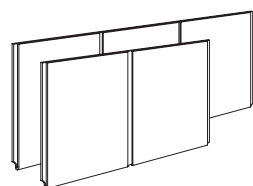

Acrylic pockets & poster holders

Top fixing pocket

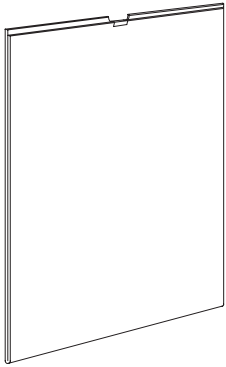

Top fixing pockets

- designed to be suspended from the top
- 3mm thick acrylic, supplied with top clip
- use with KC2-CG05 (p14)

Item Code:	Size:	Price £:
MA2HD	A2	22.00
MA1HD	A1	37.00

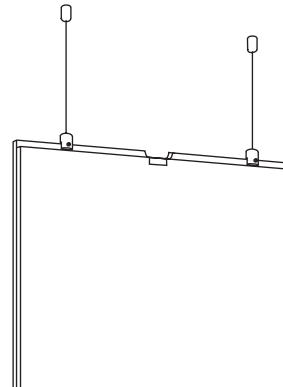

Pocket frames - for suspension on cables



Solid natural beech frames that attach directly to the cables, with no additional fittings

- complete with U-shaped acrylic pockets
- all units double sided
- profile size: 22mm wide x 20mm deep

Item Code:	Size:	1.5mm Cable centres:	Price £:
WFA5	A5	182mm	21.00
WFA4	A4	244mm	26.00
WFA3	A3	331mm	31.00
WFA2	A2	454mm	43.00

Wall mounted easy access pockets with holes

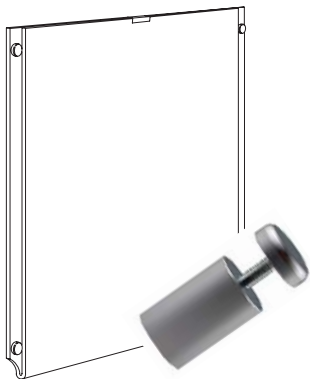

- to be mounted directly onto wall
- A5 and A4 pockets are 2mm thick acrylic, all other sizes are 3mm thick
- use with WM05-13, WM05L-20 (p9)

Portrait pockets with holes

Item Code:	Size:	Price £:
MA5PW-WM	A5	4.70
MA4PW-WM	A4	6.10
MA3PW-WM	A3	12.45
MA2PW-WM	A2	22.20
MA1PW-WM	A1	37.05
MA0PW-WM	A0	91.20

Landscape pockets with holes

Item Code:	Size:	Price £:
MA5LW-WM	A5	4.70
MA4LW-WM	A4	6.10
MA3LW-WM	A3	12.45
MA2LW-WM	A2	22.20
MA1LW-WM	A1	37.05
MA0LW-WM	A0	91.20



Wall mounted frameless acrylic poster holders

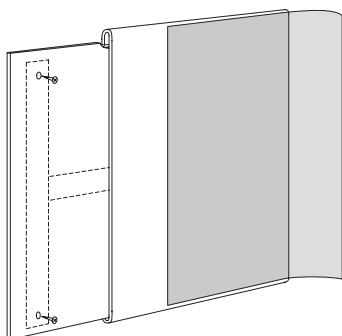

- two part pocket with a fixed back panel in foam board, which screws directly to the wall. Hook-on acrylic front creates a frameless poster display that is flat against the wall with no visible fixing
- no tools required to change the poster

Portrait

Item Code:	Size:	Price £:
AWPA4	A4	13.25
AWPA3	A3	22.00
AWPA2	A2	36.75
AWPA1	A1	62.50

Landscape

Item Code:	Size:	Price £:
AWPA4L	A4	13.25
AWPA3L	A3	22.00
AWPA2L	A2	36.75

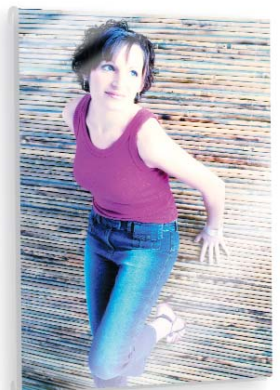

Hook-on easy access pockets



- pockets designed to be used with horizontal rods. Just hook on in desired position
- A5 and A4 pockets are 2mm thick acrylic, all other sizes are 3mm thick

Portrait

Item Code:	Size:	Price £:
HA5P	A5	4.60
HA4P	A4	5.75
HA3P	A3	10.30
HA2P	A2	20.00

Landscape

Item Code:	Size:	Price £:
HA5L	A5	4.60
HA4L	A4	5.75
HA3L	A3	10.30
HA2L	A2	20.00

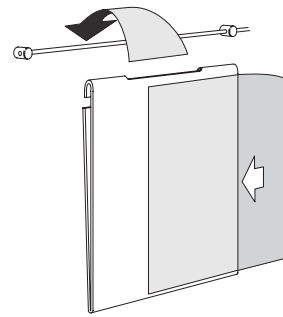

L-shaped support

To be used with wall-mounted hook-on pockets, where WM11 supports have been used to fix rods to the wall

- keeps pockets hanging vertically
- supplied with double sided adhesive

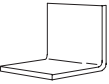

Item Code:	Price £:
HAS	0.75

- available in kit of 4 x A4 portrait pockets, complete with 1m of 6mm diameter rod and wall fixings

Kit - 4 x A4 portrait pockets

Item Code:	Size:	Price £:
KHA4W Kit	4 x A4	57.30

Hook-on leaflet dispensers



- A4 portrait hook-on leaflet dispenser. Just hook on in desired position
- 3mm thick acrylic, 40mm internal depth
- A4 sized as standard - other sizes on request

Item Code:	Size:	Price £:
HA4D	A4	12.25



KHA4D

- available in kit of 4 x A4 portrait dispensers, complete with 1m of 6mm diameter rod and wall fixings

Kit - 4 x A4 portrait dispensers

Item Code:	Size:	Price £:
KHA4D	4 x A4	83.30

Hook-on sloping shelf with lip



- sloping shelves used with wall-mounted horizontal rods
- 3mm thick acrylic, 40mm deep lip
- supplied with triangular back support
- ideal for displaying literature or folded items

Kits

- available in kits of 4 x A4 portrait shelves or 2 x A3 landscape shelves, complete with 1m of 6mm diameter rod and wall fixings

Portrait

Item Code:	Size:	Price £:
HA4S	A4	7.85

Landscape

Item Code:	Size:	Price £:
HA3S	A3	15.75

Kit - 4 x A4 portrait shelves

Item Code:	Size:	Price £:
KHA4S	4 x A4	62.70

Kit - 2 x A3 landscape shelves

Item Code:	Size:	Price £:
KHA3S	2 x A3	62.80



KHA4S



KHA3S

Fixing systems

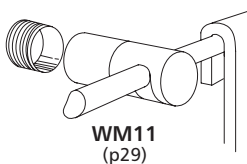

WM11
(p29)

Hook-on wall mounted pockets/leaflet dispensers:

- fix to the wall with **WM11** which will give a good solid fixing to any type of wall. Use **R1000P** for single bays and **R1500** for continuous runs
- projects centre of rod **24mm** away from the wall. Use **HAS** to ensure display hangs vertical
- fix WM11 support every 484mm on horizontal rod

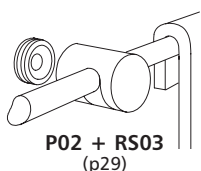

P02 + RS03
(p29)

Wall mounted supports for hook-on shelves:

- use **P02 + RS03** when fixing hook-on shelves. This support fits closely to the wall and allows the accessory to locate securely
- projects centre of rod **10mm** away from the wall

Trade and volume discounts are available - please ask

Leaflet dispensers for use on cable/rod systems

A4 dispensers

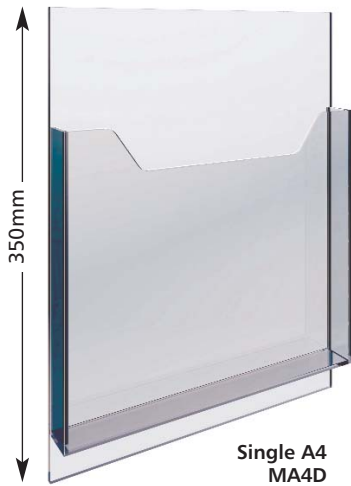

Single A4
MA4D

- leaflet dispensers to take A4 portrait leaflets
- 3mm thick acrylic. 2 x A4 versions have 4mm acrylic backs
- depth of pocket 40mm

Single sided

Item Code:	Size:	1.5mm & 3mm Cable/Rod centre:	6mm Rod centre:	10mm Rod centre:	Price £:
MA4D	Single A4	244mm	248mm	252mm	13.95
ADLA2	2 x A4	454mm	458mm	462mm	40.50
ADLA1	2 x A4	628mm	632mm	636mm	41.50

Double sided

Item Code:	Size:	1.5mm & 3mm Cable/Rod centre:	6mm Rod centre:	10mm Rod centre:	Price £:
MA4DD	Single A4	244mm	248mm	252mm	29.80
ADLA2-D	2 x A4	454mm	458mm	462mm	45.50
ADLA1-D	2 x A4	628mm	632mm	636mm	46.50



2 x A4
overall
width A2
ADLA2



2 x A4
overall
width A1
ADLA1



A5 dispensers

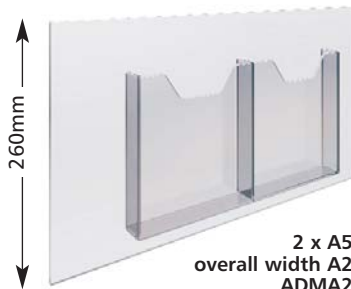

2 x A5
overall width A2
ADMA2

- leaflet dispensers to take A5 portrait leaflets
- 4mm acrylic back panel, 3mm acrylic front section
- depth of pocket 40mm

Single sided

Item Code:	Size:	1.5mm & 3mm Cable/Rod centre:	6mm Rod centre:	10mm Rod centre:	Price £:
ADMA2	2 x A5	454mm	458mm	462mm	37.50
ADMA1	3 x A5	628mm	632mm	636mm	38.50

Double sided

Item Code:	Size:	1.5mm & 3mm Cable/Rod centre:	6mm Rod centre:	10mm Rod centre:	Price £:
ADMA2-D	2 x A5	454mm	458mm	462mm	42.50
ADMA1-D	3 x A5	628mm	632mm	636mm	43.50

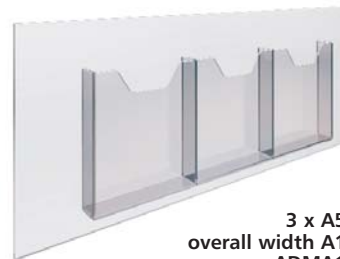

3 x A5
overall width A1
ADMA1

DL (1/3rd A4) dispensers

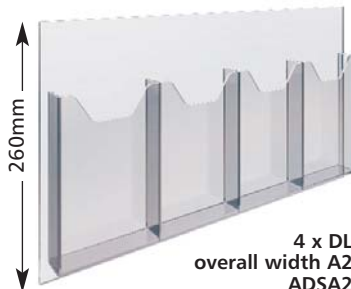

4 x DL
overall width A2
ADSA2

- leaflet dispensers to take DL (1/3rd A4) portrait leaflets
- 4mm acrylic back panel, 3mm acrylic front section
- depth of pocket 40mm

Single sided

Item Code:	Size:	1.5mm & 3mm Cable/Rod centre:	6mm Rod centre:	10mm Rod centre:	Price £:
ADSA2	4 x DL	454mm	458mm	462mm	39.50
ADSA1	5 x DL	628mm	632mm	636mm	40.50

Double sided

Item Code:	Size:	1.5mm & 3mm Cable/Rod centre:	6mm Rod centre:	10mm Rod centre:	Price £:
ADSA2-D	4 x DL	454mm	458mm	462mm	44.50
ADSA1-D	5 x DL	628mm	632mm	636mm	45.50

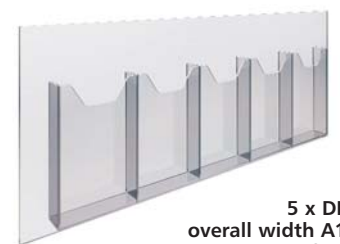

5 x DL
overall width A1
ADSA1

Angled leaflet dispensers



- 3mm thick acrylic leaflet dispensers designed to take a variety of sizes
- with 40mm lip and triangular back support
- special sizes available on request

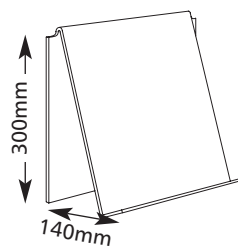

Item Code:	Size:	1.5mm & 3mm Cable/Rod centre:	6mm Rod centre:	10mm Rod centre:	Price £:
ASA4P	A4 portrait	244mm	248mm	252mm	10.40
ASA4L	A4 landscape	331mm	335mm	339mm	10.40
ASA3L	A3 landscape	454mm	458mm	462mm	17.40

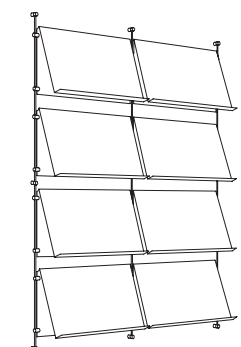

Sloping shelves For use on cable/rod systems

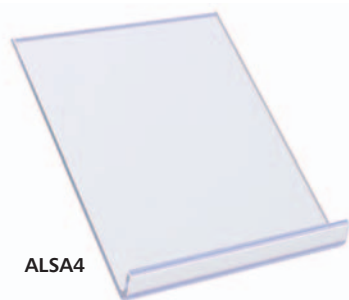

ALSAA4

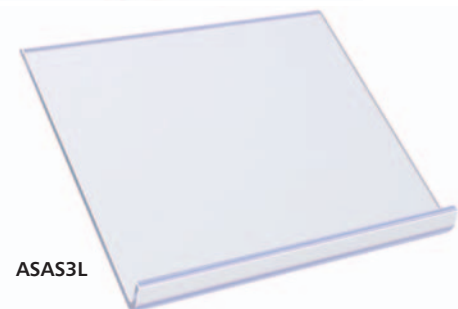

ASAS3L

- acrylic shelf with lip at front edge
- designed to be supported by four cables or rods
- ideal for A4 leaflets/booklets and product presentations
- shelf height 330mm with front lip of 45mm
- choose from clear or silicon acrylic
- shelves are 5mm thick

Item Code:	Size:	Finish:	Price £:
ALSAA4	A4	Clear	4.65
ALSAA/S	A4	Silicon	4.85
ASAS3L	A3 landscape	Clear	9.30
ASAS3L/S	A3 landscape	Silicon	9.70

Shelves have been designed to be used with 150 mm spacing between front and back cable/rods. Use with multi-position supports.



Freestanding/wall mounted leaflet dispensers



A4D/I

- injection moulded plastic
- units can be linked together

Item Code:	Size:	Dimensions (mm):	Price £:
A34D/I	DL (1/3rd A4)	104w x 200h	3.00
A5D/I	A5	155w x 200h	3.00
A4D/I	A4	230w x 300h	5.50



A34D/I



A5D/I

Freestanding menu/leaflet holders



MA4PF



MA5PF

- single sided, 2mm thick acrylic

Item Code:	Size:	Dimensions (mm):	Price £:
MA5PF	A5	148w x 210h	3.65
MA4PF	A4	210w x 300h	5.40



MA4PF-D



MA5PF-D

- Double sided, 2mm thick acrylic

Item Code:	Size:	Dimensions (mm):	Price £:
MA5PF-D	A5	148w x 220h	4.25
MA4PF-D	A4	210w x 307h	5.90

Trade and volume discounts are available - please ask

Banner & hanging rails

Gotcha strips



Aluminium banner rail with clear plastic gripper strip. Fitted with PO2 supports ready to be used on 1.5mm and 3mm cable and on 3mm, 6mm and 10mm rods.

- quick and easy way to suspend large posters. The clear plastic strips simply clip the poster into position, holding it firmly in place.

- suspend banners from the top only or use floor to ceiling cables or rods to hold banners top and bottom - ensures perfect tension at all times.

- remember to order supports - see below

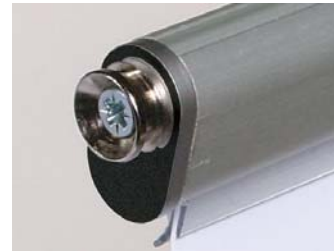

Item Code:	Size:	Price £:
A-60	60" (1524mm)	24.35
A-48	48" (1219mm)	19.85
A-40	40" (1016mm)	17.55
A-36	36" (914mm)	15.30
A-24	24" (610mm)	10.75
A-12	12" (305mm)	6.25

Single

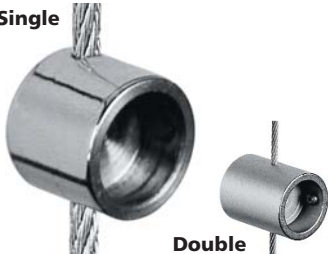

Double

Supports

Remember to add supports for Gotcha strips. Available as single or double sided

- supports listed are in satin chrome finish

Item Code: Cable/rod: Price £:

Single

CS03	1.5mm cable	3.50
CS03-3	3mm cable/rod	3.95
RS03	6mm rod	5.80
RS03-10	10mm rod	5.90

Banner rails

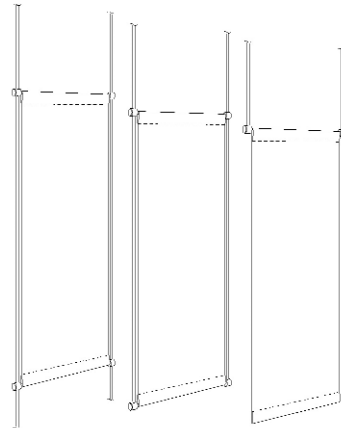

25mm diameter hanging/r

- ideal for light weight merchandise

- polished chrome rails, supplied with supports to fit directly onto 1.5mm cables/6mm rods, no additional fittings required

- shorter lengths cut to size



Item Code:	Length:	Cable centre:	Price £:
HR25C-3/PC	3' (914mm)	944mm cable centre	16.90
HR25R-3/PC	3' (914mm)	944mm rod centres	21.50

Component measurements

All measurements are in millimetres unless stated

L=Length W=Width H=Height Ø=Diameter D=Depth Int=Internal

Int=Internal

Item code:	Allen key:	Dimensions:
AC		W=19; H=11.5
ACD		W=28; H=11
ACL		W=19; H=11.5
C2		2m cable; top fitting Ø=16
C2A4F	● ●	Top fitting Ø=18; floor fitting Ø=15
C2CW-15	● ●	Wall brackets Ø=38; 40mm from wall to back cable; floor fitting Ø=16
C2CW-30	● ●	Wall brackets Ø=38; 40mm from wall to back cable; floor fitting Ø=16
C2WF-15	● ●	Wall brackets Ø=38; 40mm from wall to back cable; floor fitting Ø=15
C2WF-30	● ●	Wall brackets Ø=38; 40mm from wall to back cable; floor fitting Ø=15
C2WW-15	● ●	Wall brackets Ø=38; 40mm from wall to back cable
C2WW-30	● ●	Wall brackets Ø=38; 40mm from wall to back cable
CA4	●	4m cable; top fitting Ø=16; bottom fitting Ø=15
CA4-3	●	Top fitting Ø=16; bottom fitting Ø=15
CAA	● ●	4m cable; fittings Ø=38
CAF	● ●	4m cable; top bracket Ø=38; floor fitting Ø=15
CAT	●	Weight 100H x 30Ø; weighs 0.55kg
CCT	●	Weight 100H x 30Ø; weighs 0.55kg
CCW	●	3m cable; top fitting Ø=16; projects 40 from wall
CD-4	●	W=5; Ø=25
CD-10	●	W=5; Ø=25
CG01	●	L=20; Ø=16
CG01-3	● ●	L=21; Ø=16
CG02	●	L=32; Ø=16
CG03	●	L=15; Ø=10
CG03-3	●	L=15; Ø=10
CG04	●	L=22; Ø=10
CG04-3	●	L=22; Ø=10
CG06	●	L=20; Ø=16
CG07	●	L=32; Ø=16
CG08	●	L=31; Ø=21; 8.5mm Ø hole required 15mm from edge of panel
CG09	●	L=22; Ø=16
CG11	● ●	L=27; Ø=16
CG11-3	● ● ●	L=28; Ø=16
CG12	● ●	L=30; Ø=18
CG12-3	● ● ●	L=31; Ø=18
CG13	● ●	L=27; Ø=18
CG13-3	● ● ●	L=28; Ø=18
CG14	●	L=20; Ø=20.5
CG14-3	● ●	L=21; Ø=20.5
CG15	●	L=20; Ø=20.5
CG15-3	● ●	L=20.5; Ø=21
CG21	● ●	L=46; Ø=16
CG21-3	● ● ●	L=46; Ø=16
CG22	● ●	L=52; Ø=18
CG22-3	● ● ●	L=52; Ø=18
CG23	● ●	L=46; Ø=18
CG23-3	● ● ●	L=46; Ø=18
CH01	●	L=16; Ø=16
CH01-3	●	L=17; Ø=16
CH02	●	L=24; Ø=16
CH02-3	●	L=24; Ø=16
CQQ	●	2m Cable; top and bottom fitting Ø=16
CS01	●	D=11; Ø=16
CS01-3	●	D=11; Ø=16
CS03	● ●	L=14; Int Ø=12; Int D=6; Ø=16
CS03-3	● ● ●	L=15; Int Ø=12; Int D=6; Ø=16
CS04	● ●	L=20; Int Ø=12; Int D=6; Ø=16
CS05	● ●	L=14; Ø=16
CS05-3	● ●	L=15; Ø=16
CS06	● ●	L=20; Ø=16
CS07	● ●	L=28; Ø=16
CS08	● ●	L=12; Ø=12
CS08-3	● ●	L=16; Ø=16
CS09	●	L=17; Ø=16
CS11	● ●	L=36; Ø=18
CS11-3	● ● ●	L=37; Ø=18
CS12	●	H=28; D=14.6; Ø=16

Item code:	Allen key:	Dimensions:
CS12-3	● ●	H=27; D=26; Ø=16
CS13	● ●	L=21.5; Ø=16
CS13-3	● ●	L=23.5; Ø=16
CS21	● ●	L=64; Ø=16
CS21-3	● ●	L=64; Ø=16
CS22	●	H=28; D=21.2; Ø=16
CS23	● ●	L=35; Ø=16
CS23-3	● ●	L=37; Ø=16
CWF	●	3m cable; projects 40 from wall; floor fitting Ø=15
CWW	●	3m cable; projects 40 from wall; fitting plate Ø=38
HDS		D=15; Ø=50
HR10-3	●	L=790; Ø=10
KC2-CG05	● ●	Top fitting Ø=16; support Ø=23
KC2-CG05-10	● ●	Top fitting Ø=16;
KMDB/SI	●	H=350; D=350; cables/rods project 40mm & 340mm from wall
KMSB-25/SI		H=30; Ø=35; cable fitting 25mm from wall
KMSB/SI		H=60; Ø=60; cable fitting 50mm from wall
KMSB-100/SI		H=110; Ø=110; cable fitting 100mm from wall
P01		Ø=38
P01-PC01		H=15; Ø=38
P02		Ø=12; D=6
P08	●	H=8; Ø=16
PC01/I		L=12; Ø=16
PC31		L=18
PR01-I		L=12; Ø=16
R1000-10		L=1000; Ø=10
R1000P		L=1000; Ø=6
R1500		L=1500; Ø=6
R1500-10		L=1500; Ø=10
R500		L=500; Ø=6
R500-10		L=500; Ø=10
R500P		L=500; Ø=6
RAAS	● ●	Top fitting Ø=15; bottom fitting Ø=18
RAS	●	Top & bottom fitting Ø=18
RAS-10		Top fitting Ø=20; Bottom fitting Ø=22
RB1		1m rod; top fitting Ø=16
RB2		2m rod; top fitting Ø=16
RB3		3m rod; top fitting Ø=16
RBCF3		3m rod; top fitting Ø=16; bottom fitting Ø=15
RBT1		1m rod; top fitting Ø=16
RBT2		2m rod; top fitting Ø=16
RBT3		3m rod; top fitting Ø=16
RBTf3		3m rod; top fitting Ø=16; bottom fitting Ø=15
RC10-6	●	L=25; Ø=10
REC	●	L=16; Ø=12
REC-10		L=15; Ø=10
REC-P/BL		L=17; Ø=8.5
RG01	●	L=25; Ø=16
RG01-10	● ●	L=29; Ø=18
RG02	●	L=36; Ø=16
RG02-10	● ●	L=40; Ø=18
RG05	● ●	L=16; Ø=16
RG06	● ●	L=25; Ø=16
RG06-10	● ●	L=29; Ø=18
RG07	●	L=36; Ø=16
RG07-10	● ●	L=40; Ø=18
RG11	● ●	L=30; Ø=16
RG11-10	● ● ●	L=34; Ø=18
RG12	● ●	L=33; Ø=18
RG12-10	● ● ●	L=37; Ø=18
RG13	● ●	L=30; Ø=18
RG13-10	● ● ●	L=34; Ø=18
RG14-10	● ●	L=29; Ø=20.5
RG21	● ●	L=46; Ø=16
RG21-10	● ● ●	L=68; Ø=16
RG22	● ●	L=52; Ø=18
RG22-10	● ● ●	L=56; Ø=18

Item code:	Allen key:	Dimensions:
RG23	● ●	L=46; Ø=18
RG23-10	● ● ●	L=50; Ø=18
RGN01	●	L=25; Ø=16
RH01	●	L=19; Ø=16
RH01-10	●	L=23; Ø=18
RH02	●	L=24; Ø=16
RH02-10	●	L=28; Ø=18
RP	●	Ø=18
RPA	● ●	3m cable; projects 40 from wall; floor fitting Ø=15
RR01	● ●	L=31; Ø=16
RR01-10	● ●	L=40; Ø=18
RR01-3/10	● ● ●	L=33; Ø=18
RR01-3/6	● ● ●	L=29; Ø=16
RR01-6/10	● ●	L=56; Ø=18
RS		Ø=18
RS01	●	D=11; Ø=16
RS03	● ●	L=17.5; Int Ø=12; Int D=6; Ø=16
RS03-10	● ●	L=22; Ø=18
RS04	● ●	L=21; Int Ø=12; Int D=6; Ø=16
RS04-10	● ●	L=26; Ø=18
RS05	● ●	L=17; Ø=16
RS05-10	● ●	L=22; Ø=18
RS06	● ●	L=20; Ø=16
RS06-10	● ●	L=26; Ø=18
RS08	● ●	L=18; Ø=16
RS-10		L=22; Ø=20
RS11	● ●	L=39; Ø=16
RS11-10	● ●	L=43; Ø=18
RS12	●	H=28; D=18.1; Ø=16
RS12-10	● ●	L=20; Ø=18
RS13	● ●	L=25; Ø=16
RS13-10	●	L=30; Ø=18
RS21	● ●	L=64; Ø=16
RS21-10	● ●	L=68; Ø=18
RS22	● ●	L=30; D=24.2; Ø=16
RS23	● ●	L=38; Ø=16
RS23-10	●	L=38; Ø=18
RSA	●	Ø=15
WM01	● ●	L=30
WM02	● ●	L=30
WM03	●	L=16
WM04	●	L=16
WM05-13	●	L=25; Ø=16
WM05L-20	●	L=40; Ø=16
WM06		L=19; Ø=16
WM07	●	L=28; Ø=16
WM08	●	L=32; Ø=16
WM09	● ●	L=31; Ø=16
WM10	●	L=39; Ø=16; 24mm from wall
WM11	● ●	L=31; Ø=16
WM11-10	● ●	L=36; Ø=18
WM11L-10	● ●	L=59; Ø=18
WM12	●	L=20; Ø=12
WM15	●	L=25; Ø=25
WM16	●	L=50; Ø=25
WM17	●	L=75; Ø=25
WM18	●	L=25; Ø=16
WM19		Ø=16
WM20	●	Ø=25; D=5.5
WMS-2		D=2
WMS-3		D=3

ALLEN KEYS:

To see which allen key each component requires, check the colour code in the list above against the grid below:

AK1.5	1.5mm	●
AK2.0	2.0mm	●
AK2.5	2.5mm	●
AK3.0	3.0mm	●
AK4.0	4.0mm	●
AK5.0	5.0mm	●
AK6.0	6.0mm	●

create the perfect display for

Wall mounted...

Spies Hecker gratefully acknowledges the support of the following companies:



W&G Mechanical Services Co. Ltd
INCORPORATING GARMAT UK.
SPRAYBOOTH AND BODYSHOP EQUIPMENT SPECIALISTS

3M

Innovation • Experience • Quality
minden SATA FESTO

Farécla
The Simple Solution to Paintwork Rectification



Signage suspended from the ceiling...



Floor-to-ceiling creativity...



Versatile cable and rod systems that allow you to create exactly the display you want.

you...

Freestanding displays

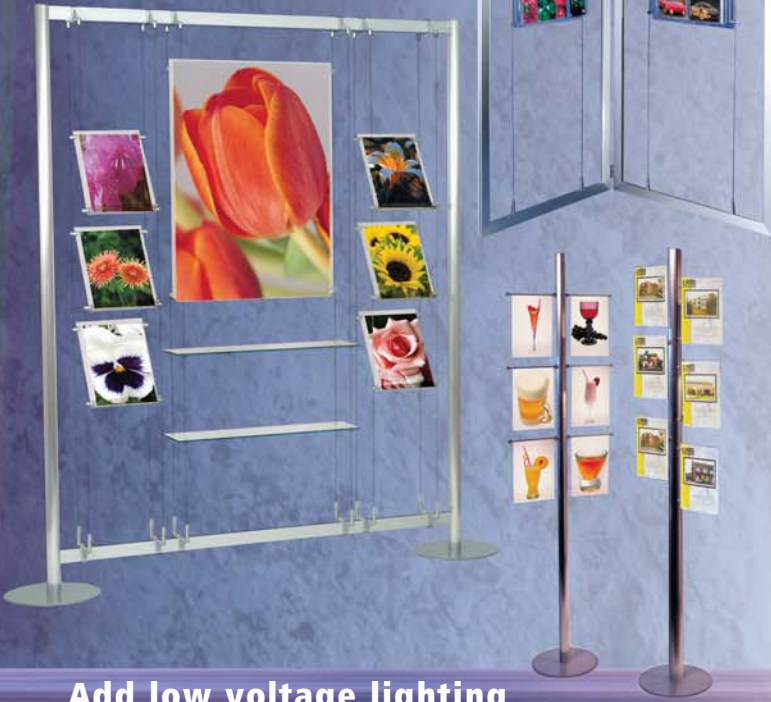

Add low voltage lighting



Add movement...

and watch your sales increase



Floating multi-media presentations...



The very latest digital displays will add sound and movement to your displays...and increase sales too...

Add flexibility to your display with channel...



Incredibly slim, bright light boxes create maximum impact...



Ultra-bright, slim light boxes can be suspended or wall mounted... used on their own or combined with other displays...

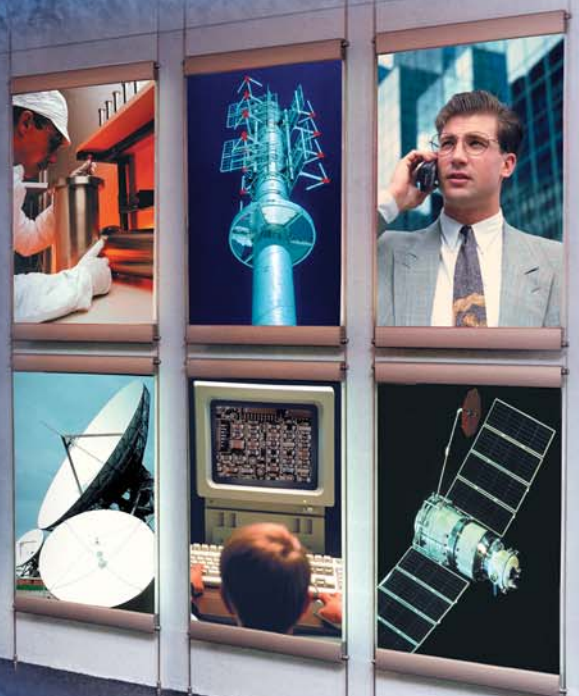



DISPLAY EXHIBITION
& SHOP EQUIPMENT

John Ellis Shop Equipment Limited

TEL: 01223 892283 FAX: 01223 891572

johnellis@shopequip.co.uk

www.shopequip.co.uk