

CABLE SYSTEMS

the display collection



**JOHN
ELLIS**

DISPLAY EXHIBITION
& SHOP EQUIPMENT



Cable systems



* Projects designed and installed by Atlas Display (DHB) Ltd

creative

flexible

highest quality

easy to install

- Choose from 1.5mm or 3mm thick galvanised steel cables - will not fray, kink or mark, unlike stainless steel
- 1.5mm cable supports up to 120kg, 3mm cable up to 200kg
- Designed and manufactured to the highest possible standards of quality
- 5 year guarantee on all metal components
- Extensive range of components and accessories ensures complete design flexibility
- Low-voltage lighting can be fully integrated onto the cable systems
- Stylish yet discreet design
- Easy to install, with an installation service available if required
- Available in 3 standard finishes - satin chrome, polished chrome and brass. Special finishes are available on request



1.5mm cable - fitting options

Ceiling to floor

- the basic kit for fixing between ceiling and floor
- includes top and bottom fittings, 4m of cable and spring tensioner
- also available with insulated cable for use with lighting on exhibition stands



Item code: Finish: Price £:

CA4	Satin Chrome	12.50
CA4/PC	Polished Chrome	15.00
CA4/BR	Polished Brass	16.25

With insulated cable:

CA4S	Satin Chrome	14.50
CA4S/PC	Polished Chrome	17.00
CA4S/BR	Polished Brass	18.25

Ceiling to wall

- ideal for supporting signs and graphics
- includes top and bottom fittings, spring tensioner and 3m cable



Item code: Finish: Price £:

CCW	Satin Chrome	14.00
CCW/PC	Polished Chrome	16.80
CCW/BR	Polished Brass	18.20

Wall to wall

- use for suspending signs and graphics
- includes top and bottom fittings, spring tensioner and 3m cable



Item code: Finish: Price £:

CWW	Satin Chrome	15.00
CWW/PC	Polished Chrome	18.00
CWW/BR	Polished Brass	19.50

Wall to floor

- use for suspending signs and graphics
- includes top and bottom fittings, spring tensioner and 3m cable

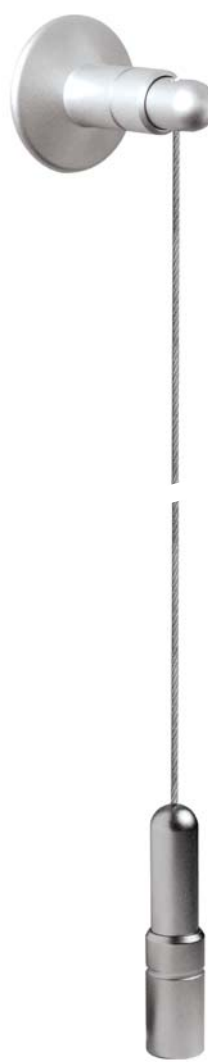

Item code: Finish: Price £:

CWF	Satin Chrome	14.00
CWF/PC	Polished Chrome	16.80
CWF/BR	Polished Brass	18.20

Angled top and bottom

- use on sloping or flat surfaces
- includes top and bottom fittings, spring tensioner and 4m cable



Item code: Finish: Price £:

Angled top to angled bottom:

CAA	Satin Chrome	19.45
CAA/PC	Polished Chrome	23.30
CAA/BR	Polished Brass	25.30

Angled top to regular bottom fitting:

CAF	Satin Chrome	14.00
CAF/PC	Polished Chrome	16.80
CAF/BR	Polished Brass	18.20

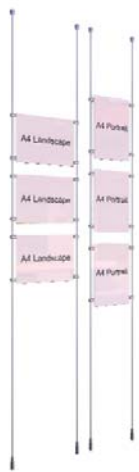

K3A4L K3A4

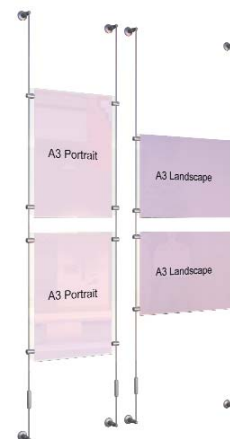
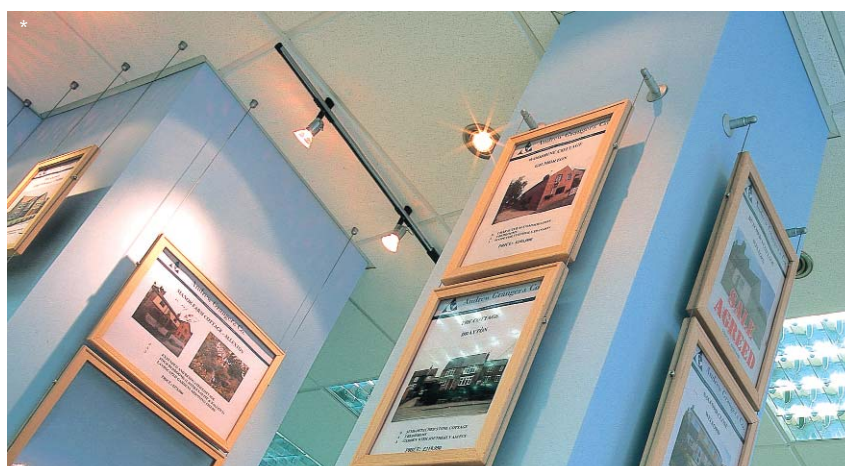

KW2A3 KW2A3L

All cables can be supplied in longer lengths. Add 50p for each extra metre of cable.



1.5mm cable - fitting options

Ceiling suspended fittings

Ceiling fitting supplied with 2m long cable

- ideal for supporting signs



Item Code:	Finish:	Price £:
C2	Satin Chrome	3.50
C2/PC	Polished Chrome	4.20
C2/BR	Polished Brass	4.55

Top cable fitting and panel clamp

- 2m long cable with top fitting and panel clamp to take up to **7mm** or **10mm** thick panel
- ideal for supporting signs



For panels up to **7mm** thick

Item Code:	Finish:	Price £:
KC2-CG05	Satin Chrome	5.65
KC2-CG05/PC	Polished Chrome	6.80
KC2-CG05/BR	Polished Brass	7.35

For panels up to **10mm** thick

Item Code:	Finish:	Price £:
KC2-CG05-10	Satin Chrome	5.65
KC2-CG05-10/PC	Polished Chrome	9.60
KC2-CG05-10/BR	Polished Brass	10.40



Ceiling fitting with cable and weight

- top fitting with **4m** long cable and bottom weight measuring 100mm h x 30mm dia. Weight 0.55kg
- weight ensures taut cable for signs and banners



Item Code:	Finish:	Price £:
CCT	Satin Chrome	25.00

Angled ceiling fitting with cable and weight

- wall mounted support with adjustable angle. Weight 0.55kg
- weight ensures taut cable for signs and banners

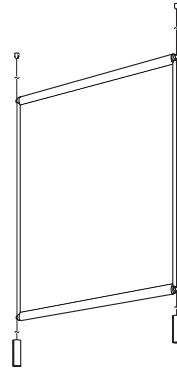

Item Code:	Finish:	Price £:
CAT	Satin Chrome	32.00

Quick fit cable

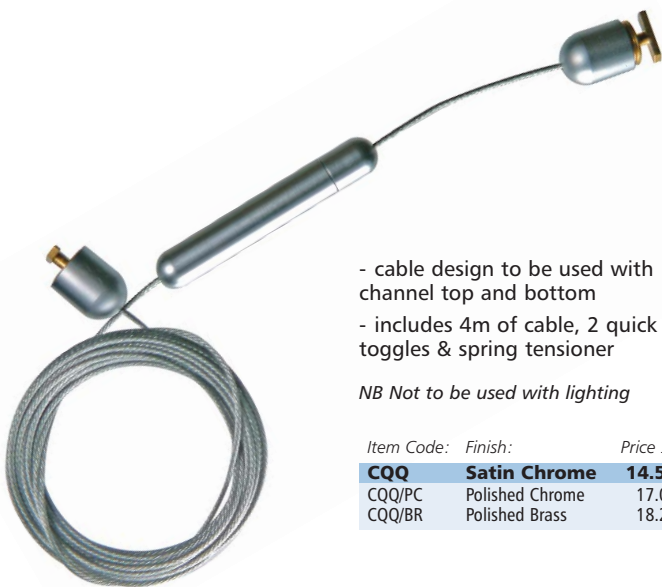

- cable design to be used with channel top and bottom
- includes 4m of cable, 2 quick fit toggles & spring tensioner

NB Not to be used with lighting

Item Code:	Finish:	Price £:
CQQ	Satin Chrome	14.50
CQQ/PC	Polished Chrome	17.00
CQQ/BR	Polished Brass	18.25

Extra strong ceiling/wall fitting

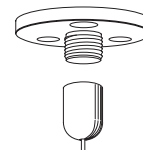

- can be used with any standard ceiling fitting or wall mount

Item Code:	Finish:	Price £:
HDS	Satin Chrome	3.85

Decorative cover disc - thread through

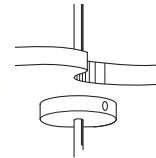

- can be used with any standard cable or 3mm rod
- use below false ceiling to hide hole, giving a professional finish

Item Code:	Finish:	Price £:
CD-4	Satin Chrome	1.55

Decorative support plate



- can be used with any standard ceiling fitting or wall mount

Item Code:	Finish:	Price £:
P01-PC01	Satin Chrome	2.95

Full dimensions - p13

Trade and volume discounts are available - please ask



Double cable fittings

- available in **150mm** and **300mm** cable centres
- creates a stylish support for shelving and graphics

Wall to wall fittings with two 3m cables

150mm cable centres

Item Code:	Finish:	Price £:
C2WW-15	Satin chrome	47.00
C2WW-15/PC	Polished chrome	56.40
C2WW-15/BR	Polished Brass	61.10

300mm cable centres

Item Code:	Finish:	Price £:
C2WW-30	Satin chrome	48.00
C2WW-30/PC	Polished chrome	57.60
C2WW-30/BR	Polished Brass	62.40



KWSCA1 - see website for full range of shelving kits

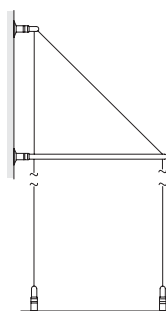
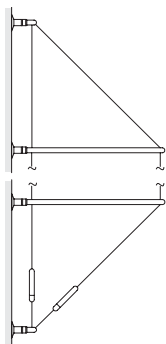

Wall to floor fittings with two 3m cables

150mm cable centres

Item Code:	Finish:	Price £:
C2WF-15	Satin chrome	40.00
C2WF-15/PC	Polished chrome	48.00
C2WF-15/BR	Polished Brass	52.00

300mm cable centres

Item Code:	Finish:	Price £:
C2WF-30	Satin chrome	41.00
C2WF-30/PC	Polished chrome	49.20
C2WF-30/BR	Polished Brass	53.30

Ceiling to wall fittings with two 3m cables

150mm cable centres

Item Code:	Finish:	Price £:
C2CW-15	Satin chrome	40.00
C2CW-15/PC	Polished chrome	48.00
C2CW-15/BR	Polished Brass	52.00

300mm cable centres

Item Code:	Finish:	Price £:
C2CW-30	Satin chrome	41.00
C2CW-30/PC	Polished chrome	49.20
C2CW-30/BR	Polished Brass	53.30

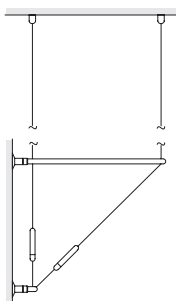

Twin cable fittings

Twin cable with single ceiling fitting

- single ceiling fitting, with two **4m** long cables fixed to the floor
- spacer bar to ensure cable centres **300mm**
- other sizes available on request
- tensioners fitted at bottom

Item Code:	Finish:	Price £:
C2A4F	Satin Chrome	29.50
C2A4F/PC	Polished Chrome	35.40
C2A4F/BR	Polished Brass	38.35

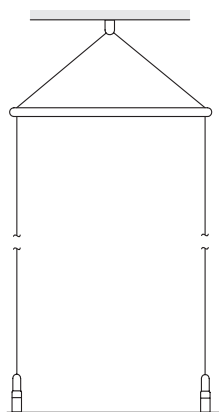

Trade and volume discounts are available - please ask

Full dimensions - p13

All cables can be supplied in longer lengths. Add £1.00 for each extra metre for double cables.

Polished Chrome:  Polished Brass: 

Panel clamps - 1.5mm cable

Vertical clamps

For panels up to 4mm thick:



Item Code:	Finish:	Price £:
Single		
CG03	Satin Chrome	2.95
CG03/PC	Polished Chrome	3.55
CG03/BR	Polished Brass	3.85
Double		
CG04	Satin Chrome	4.20
CG04/PC	Polished Chrome	5.05
CG04/BR	Polished Brass	5.45

For panels up to 7mm thick:

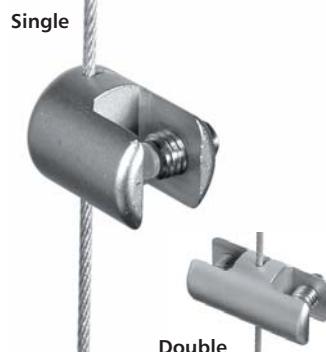

Item Code:	Finish:	Price £:
Single		
CG01	Satin Chrome	3.90
CG01/PC	Polished Chrome	4.70
CG01/BR	Polished Brass	5.05
Double		
CG02	Satin Chrome	4.50
CG02/PC	Polished Chrome	5.40
CG02/BR	Polished Brass	5.85

For panels up to 12.7mm thick:



Item Code:	Finish:	Price £:
CG14	Satin Chrome	4.00
CG14/PC	Polished Chrome	4.80
CG14/BR	Polished Brass	5.20

For panels up to 12.7mm thick with holes:



- with insert for holes. Supports two 6mm thick glass panels with poster between.

Item Code:	Finish:	Price £:
CG08	Satin Chrome	7.90
CG08/PC	Polished Chrome	9.50
CG08/BR	Polished Brass	10.25

Multi-position clamps - can be locked at any angle

For panels up to 7mm thick:

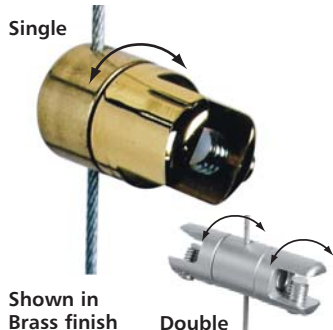

Item Code:	Finish:	Price £:
Single		
CG11	Satin Chrome	4.90
CG11/PC	Polished Chrome	5.90
CG11/BR	Polished Brass	6.95
Double		
CG21	Satin Chrome	7.20
CG21/PC	Polished Chrome	8.65
CG21/BR	Polished Brass	11.40

For panels up to 10mm thick:

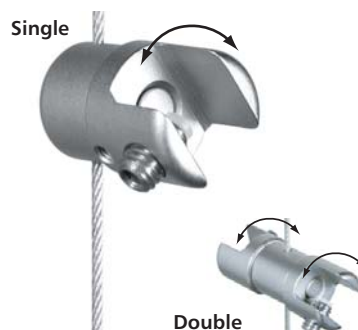

Item Code:	Finish:	Price £:
Single		
CG13	Satin Chrome	5.50
CG13/PC	Polished Chrome	6.60
CG13/BR	Polished Brass	7.15
Double		
CG23	Satin Chrome	7.90
CG23/PC	Polished Chrome	9.50
CG23/BR	Polished Brass	10.30

Clamps for wide panels - top/bottom clamps for panels wider than the distance between cables

For panels up to 7mm thick:



Item Code:	Finish:	Price £:
CG09	Satin Chrome	3.75
CG09/PC	Polished Chrome	4.50
CG09/BR	Polished Brass	4.90

Multi-position clamps for panels up to 7mm thick:

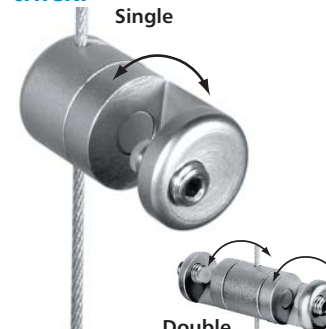

- can be locked into any position

Item Code:	Finish:	Price £:
Single		
CG12	Satin Chrome	5.60
CG12/PC	Polished Chrome	6.75
CG12/BR	Polished Brass	7.30
Double		
CG22	Satin Chrome	9.50
CG22/PC	Polished Chrome	11.40
CG22/BR	Polished Brass	12.35

Full dimensions - p13

Trade and volume discounts are available - please ask



Panel supports - 1.5mm cable

Supports for panels with holes

For panels 5-6mm thick



- hole size **6mm** diameter
- supports for panels up to **20mm** thick available on request

Item Code: Finish: Price £:

Single		
CS13	Satin Chrome	4.80
CS13/PC	Polished Chrome	5.75
CS13/BR	Polished Brass	6.25
Double		
CS23	Satin Chrome	6.50
CS23/PC	Polished Chrome	7.80
CS23/BR	Polished Brass	8.45

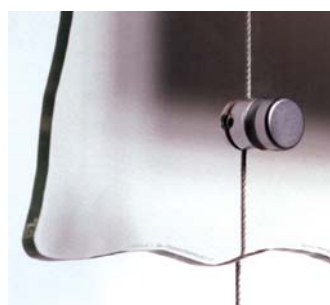

CS13 & CS23
for extra thick panels up to 20mm, specify size required.
Add £1.00 to price shown.
Ref example: CS13/S

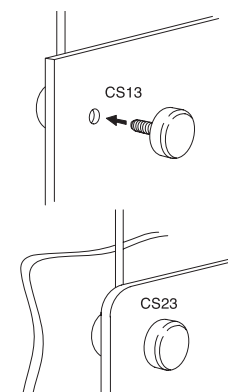

Supports for screw fix panels



Support

- support for any item fitted with boss fitting

Item Code: Finish: Price £:

Single		
CS03	Satin Chrome	3.50
CS03/PC	Polished Chrome	4.20
CS03/BR	Polished Brass	4.55
Double		
CS04	Satin Chrome	5.75
CS04/PC	Polished Chrome	6.90
CS04/BR	Polished Brass	7.50



P02 Boss

- Boss for use with supports CS03/CS04
- use with up to No. 10 countersunk wood screw or bolt

Item Code: Finish: Price £:

P02	Nickel	0.40
------------	---------------	-------------

Hooks

Hook for panels up to 3mm thick with holes

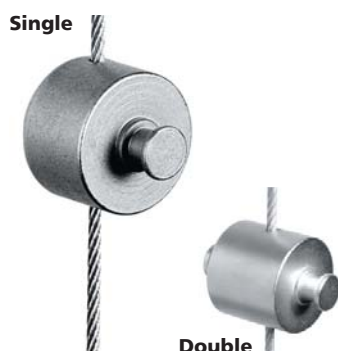

Item Code: Finish: Price £:

Single		
CH01	Satin Chrome	2.50
CH01/PC	Polished Chrome	3.00
CH01/BR	Polished Brass	3.25
Double		
CH02	Satin Chrome	3.15
CH02/PC	Polished Chrome	3.80
CH02/BR	Polished Brass	4.10

Picture hooks



Item Code: Finish: Price £:

Single		
CS12	Satin Chrome	5.80
Double - not shown		
CS22	Satin Chrome	11.35

Nylon tip screws



All panel and shelving clamps are supplied with nylon tip as standard*

- nylon tip protects glass and acrylic

* except CG03, CG04

Full dimensions - p13

Trade and volume discounts are available - please ask



Shelf supports - 1.5mm cable

Under-shelf support



- locates under shelf
- inconspicuous
- for drilled and slotted shelf
- shelf hole size **10mm**, slot width **2mm**

Item Code:	Finish:	Price £:
CS01	Satin Chrome	1.75
CS01/PC	Polished Chrome	2.50
CS01/BR	Polished Brass	2.80

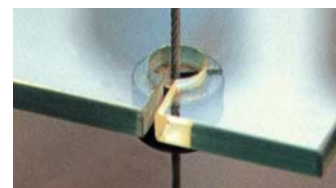

Supports for wooden or glass shelves

Shelf support

Single



- adjustable to any angle of slope
- can be locked into position
- for glass shelves

Item Code:	Finish:	Price £:
Single		
CS11	Satin Chrome	5.55
CS11/PC	Polished Chrome	6.65
CS11/BR	Polished Brass	7.20
Double		
CS21	Satin Chrome	9.50
CS21/PC	Polished Chrome	11.40
CS21/BR	Polished Brass	12.35

Screw to retain glass shelves



- Used with CS11 or CS21 to hold **6mm** thick as standard
- flush finish
- plastic insert to protect glass
- hole **6mm** dia, **6mm** thick glass
- hole **12mm** from the edge of glass

Item Code:	Finish:	Price £:
P08	Satin Chrome	3.65
P08/PC	Polished Chrome	4.65
P08/BR	Polished Brass	4.90

Clamps for glass shelves

Clamp for glass shelves up to 7mm thick

Single



- for glass shelves without holes

Item Code:	Finish:	Price £:
Single		
CG06	Satin Chrome	3.60
CG06/PC	Polished Chrome	4.30
CG06/BR	Polished Brass	4.70
Double		
CG07	Satin Chrome	5.60
CG07/PC	Polished Chrome	6.70
CG07/BR	Polished Brass	7.30

Clamp for glass shelves up to 12.7mm thick

- for glass shelves without holes



Item Code:	Finish:	Price £:
CG15	Satin Chrome	3.70
CG15/PC	Polished Chrome	4.45
CG15/BR	Polished Brass	4.80

Multi-position clamps for glass shelves

Multi-position clamp for glass shelves up to 7mm thick

Single

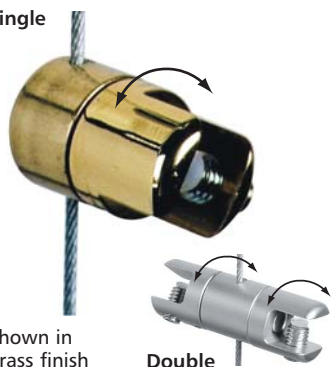

- adjustable to any angle
- can be locked into position

Item Code:	Finish:	Price £:
Single		
CG11	Satin Chrome	4.90
CG11/PC	Polished Chrome	5.90
CG11/BR	Polished Brass	6.95
Double		
CG21	Satin Chrome	7.20
CG21/PC	Polished Chrome	8.65
CG21/BR	Polished Brass	11.40

Shown in Brass finish

Multi-position clamp for glass shelves up to 10mm thick

Single



- adjustable to any angle
- can be locked into position

Item Code:	Finish:	Price £:
Single		
CG13	Satin Chrome	5.50
CG13/PC	Polished Chrome	6.60
CG13/BR	Polished Brass	7.15
Double		
CG23	Satin Chrome	7.90
CG23/PC	Polished Chrome	9.50
CG23/BR	Polished Brass	10.30

Full dimensions - p13

Trade and volume discounts are available - please ask



Shelf & rod supports - 1.5mm cable

Supports to hold rods

Rod support

Single



Double



- for 6mm diameter rods
- rods will hold acrylic pockets, leaflet holders, banners & graphics

Item Code: Finish: Price £:

Single		
CS05	Satin Chrome	3.45
CS05/PC	Polished Chrome	4.15
CS05/BR	Polished Brass	4.50
Double		
CS06	Satin Chrome	6.50
CS06/PC	Polished Chrome	7.80
CS06/BR	Polished Brass	8.45

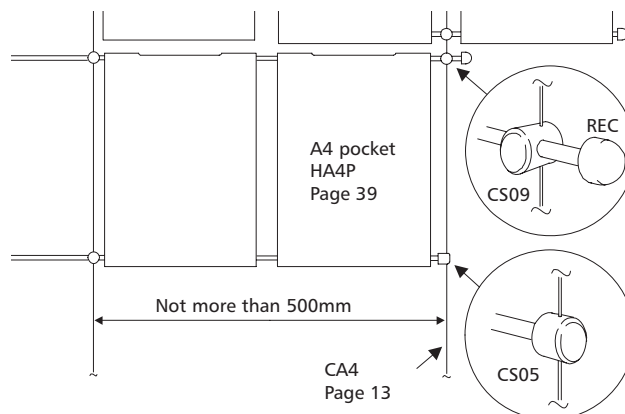

Rod support - fixed position

- to hold 6mm rod



Item Code: Finish: Price £:

CS09	Satin Chrome	3.80
CS09/PC	Polished Chrome	4.55
CS09/BR	Polished Brass	4.95

Rod support - Multi-position

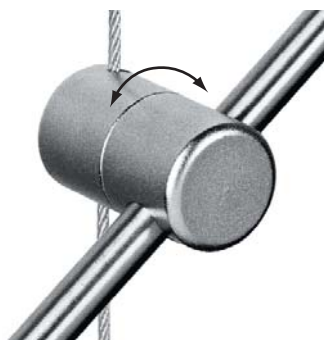

- to hold 6mm rod
- can be locked in any position

Item Code: Finish: Price £:

CS07	Satin Chrome	6.95
CS07/PC	Polished Chrome	8.35
CS07/BR	Polished Brass	9.05

Unthreaded rod - 6mm dia



Item Code: Finish: Price £:

0.5m rod		
R500P	Satin Chrome	4.50
R500P/PC	Polished Chrome	8.35
R500P/BR	Polished Brass	8.35
1m rod		
R1000P	Satin Chrome	7.00
R1000P/PC	Polished Chrome	12.60
R1000P/BR	Polished Brass	12.60

Rod end caps



Item Code: Finish: Price £:

End cap for 6mm rod		
REC	Satin Chrome	2.00
REC/PC	Polished Chrome	2.40
REC/BR	Polished Brass	2.60
Black PVC end cap for 6mm rod		
REC-P/BL	Black	0.25



Full dimensions - p13

Trade and volume discounts are available - please ask

Polished Chrome:  Polished Brass: 

Shelf supports - 1.5mm cable

Under-shelf support



- locates under shelf
- inconspicuous
- for drilled and slotted shelf
- shelf hole size **10mm**, slot width **2mm**

Item Code:	Finish:	Price £:
CS01	Satin Chrome	1.75
CS01/PC	Polished Chrome	2.50
CS01/BR	Polished Brass	2.80

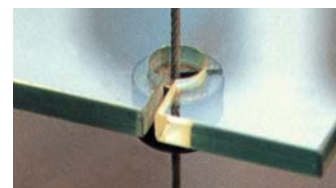

Supports for wooden or glass shelves

Shelf support

Single



- adjustable to any angle of slope
- can be locked into position
- for glass shelves

Item Code:	Finish:	Price £:
Single		
CS11	Satin Chrome	5.55
CS11/PC	Polished Chrome	6.65
CS11/BR	Polished Brass	7.20
Double		
CS21	Satin Chrome	9.50
CS21/PC	Polished Chrome	11.40
CS21/BR	Polished Brass	12.35

Screw to retain glass shelves



- Used with CS11 or CS21 to hold **6mm** thick as standard
- flush finish
- plastic insert to protect glass
- hole **6mm** dia, **6mm** thick glass
- hole **12mm** from the edge of glass

Item Code:	Finish:	Price £:
P08	Satin Chrome	3.65
P08/PC	Polished Chrome	4.65
P08/BR	Polished Brass	4.90

Clamps for glass shelves

Clamp for glass shelves up to 7mm thick

Single



- for glass shelves without holes

Item Code:	Finish:	Price £:
Single		
CG06	Satin Chrome	3.60
CG06/PC	Polished Chrome	4.30
CG06/BR	Polished Brass	4.70
Double		
CG07	Satin Chrome	5.60
CG07/PC	Polished Chrome	6.70
CG07/BR	Polished Brass	7.30

Clamp for glass shelves up to 12.7mm thick

- for glass shelves without holes



Item Code:	Finish:	Price £:
CG15	Satin Chrome	3.70
CG15/PC	Polished Chrome	4.45
CG15/BR	Polished Brass	4.80

Multi-position clamps for glass shelves

Multi-position clamp for glass shelves up to 7mm thick

Single

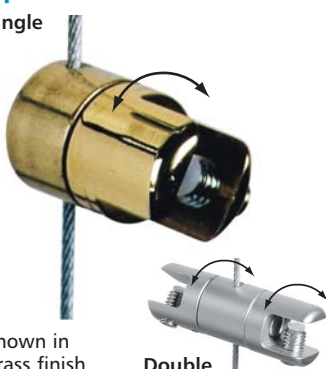

- adjustable to any angle
- can be locked into position

Item Code:	Finish:	Price £:
Single		
CG11	Satin Chrome	4.90
CG11/PC	Polished Chrome	5.90
CG11/BR	Polished Brass	6.95
Double		
CG21	Satin Chrome	7.20
CG21/PC	Polished Chrome	8.65
CG21/BR	Polished Brass	11.40

Shown in Brass finish

Multi-position clamp for glass shelves up to 10mm thick

Single



- adjustable to any angle
- can be locked into position

Item Code:	Finish:	Price £:
Single		
CG13	Satin Chrome	5.50
CG13/PC	Polished Chrome	6.60
CG13/BR	Polished Brass	7.15
Double		
CG23	Satin Chrome	7.90
CG23/PC	Polished Chrome	9.50
CG23/BR	Polished Brass	10.30

Full dimensions - p13

Trade and volume discounts are available - please ask



Multi-position clamps for panels and shelves

For panels up to 7mm thick

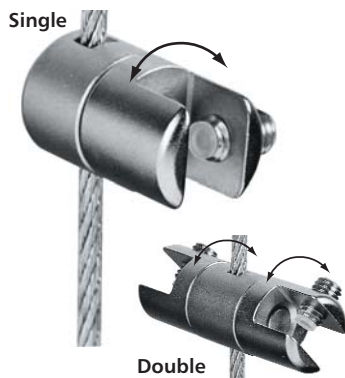

- adjustable to any angle
- can be locked into position

Item Code: Finish: Price £:

Single		
CG11-3	Satin Chrome	5.20
CG11-3/PC	Polished Chrome	7.15
CG11-3/BR	Polished Brass	7.75
Double		
CG21-3	Satin Chrome	7.60
CG21-3/PC	Polished Chrome	10.65
CG21-3/BR	Polished Brass	11.55

For panels up to 10mm thick

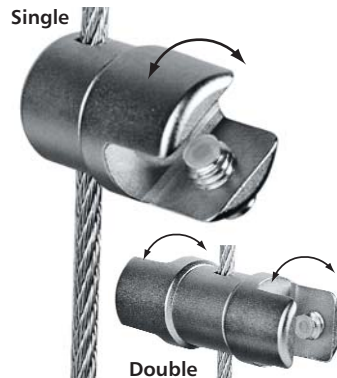

- adjustable to any angle
- can be locked into position

Item Code: Finish: Price £:

Single		
CG13-3	Satin Chrome	5.70
CG13-3/PC	Polished Chrome	7.55
CG13-3/BR	Polished Brass	8.15
Double		
CG23-3	Satin Chrome	8.60
CG23-3/PC	Polished Chrome	11.50
CG23-3/BR	Polished Brass	12.40

Clamp for glass shelves

For panels up to 12.7mm thick



Item Code: Finish: Price £:

CG15-3	Satin Chrome	4.20
CG15-3/PC	Polished Chrome	5.05
CG15-3/BR	Polished Brass	5.45

Under-shelf support



- locates under shelf
- shelf is drilled - hole size **10mm**
- inconspicuous

Item Code: Finish: Price £:

CS01-3	Satin Chrome	2.10
CS01-3/PC	Polished Chrome	2.85
CS01-3/BR	Polished Brass	3.10

Supports for wooden or glass shelves

Shelf support



- adjustable to any angle of slope
- can be locked into position
- for glass shelves add ref. P08 (see right)

Item Code: Finish: Price £:

Single		
CS11-3	Satin Chrome	5.75
CS11-3/PC	Polished Chrome	6.90
CS11-3/BR	Polished Brass	7.45
Double		
CS21-3	Satin Chrome	9.80
CS21-3/PC	Polished Chrome	11.75
CS21-3/BR	Polished Brass	12.75

Screw to retain glass shelves



- Used with CS11-3 or CS21-3 to hold **6mm** thick as standard
- flush finish
- plastic insert to protect glass
- hole **6mm** dia, **6mm** thick glass
- hole **12mm** from the edge of glass

Item Code: Finish: Price £:

P08	Satin Chrome	3.65
P08/PC	Polished Chrome	4.65
P08/BR	Polished Brass	4.90

Supports for screw fix panels



- support for any item fitted with boss fitting P02
- perfect to support hanging rails

Item Code: Finish: Price £:

CS03-3	Satin Chrome	3.95
CS03-3/PC	Polished Chrome	4.75
CS03-3/BR	Polished Brass	5.15

P02 Boss

- Boss for use with supports CS03/CS04
- use with up to No. 10 countersunk wood screw or bolt

Item Code: Finish: Price £:

P02	Nickel	0.40
------------	---------------	-------------

Hooks

Hook for panels up to 3mm thick with holes

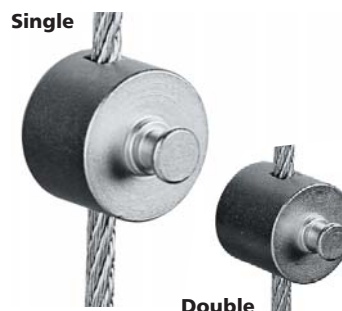

Item Code: Finish: Price £:

Single		
CH01-3	Satin Chrome	2.65
CH01-3/PC	Polished Chrome	3.70
CH01-3/BR	Polished Brass	3.95
Double		
CH02-3	Satin Chrome	3.45
CH02-3/PC	Polished Chrome	4.15
CH02-3/BR	Polished Brass	4.45

Full dimensions - p13

Trade and volume discounts are available - please ask



Samples

Increase your sales by using samples which enable you to show the quality and design of the product. Remember - once your client sees and touches the product they normally purchase, as they are so delighted with the quality and design. The samples have been vastly reduced in price and are NOT subject to any discounts.

Sample snake

- 1.5mm cable supplied with top/bottom fittings.
- length 1 metre
- fittings: CG01, CG02, CG03/PC, CG04, CG06, CG09, CG11, CS01/BR, CS13

Item Code: **CSC** Price £: **35.00**

Sample frame

- complete frame ideal for dropping in your briefcase
- extensive range of cable and rod samples with a 1/3 A4 acrylic pocket
- size 430mm wide x 310mm high

Item Code: **CSF** Price £: **100.00**

Sample 3mm rod

- 3mm rod (100mm length) supplied with REC end cap and a CG03 support

Item Code: **RB1-S** Price £: **5.25**

Freestyle sample frame

- supplied with quick fit cables and a business card holder supported with CG03 supports

Item Code: **SFS** Price £: **49.97**

Sample cases

Order a case and we will give you a credit on your account against your next order - £50 credit for the large case and £25 credit for small case (valid on orders over £200).

Small

- small lightweight blue plastic case with cables/rods and wall mounted supports

- 350mm w x 300mm h x 65mm d

Large:

Large heavy duty aluminium case with a comprehensive range of cable/rod fittings, plus low voltage lighting sample

- 390mm w x 290mm h x 135mm d



Item Code: **SC/S** Size: **Small** Price £: **110.00**
 Item Code: **SC/L** Size: **Large** Price £: **250.00**

Component measurements

All measurements are in millimetres unless stated

L=Length W=Width H=Height Ø=Diameter D=Depth Int=Internal

Int=Internal

Item code:	Allen key:	Dimensions:
AC		W=19; H=11.5
ACD		W=28; H=11
ACL		W=19; H=11.5
C2		2m cable; top fitting Ø=16
C2A4F	● ●	Top fitting Ø=18; floor fitting Ø=15
C2CW-15	● ●	Wall brackets Ø=38; 40mm from wall to back cable; floor fitting Ø=16
C2CW-30	● ●	Wall brackets Ø=38; 40mm from wall to back cable; floor fitting Ø=16
C2WF-15	● ●	Wall brackets Ø=38; 40mm from wall to back cable; floor fitting Ø=15
C2WF-30	● ●	Wall brackets Ø=38; 40mm from wall to back cable; floor fitting Ø=15
C2WW-15	● ●	Wall brackets Ø=38; 40mm from wall to back cable
C2WW-30	● ●	Wall brackets Ø=38; 40mm from wall to back cable
CA4	●	4m cable; top fitting Ø=16; bottom fitting Ø=15
CA4-3	●	Top fitting Ø=16; bottom fitting Ø=15
CAA	● ●	4m cable; fittings Ø=38
CAF	● ●	4m cable; top bracket Ø=38; floor fitting Ø=15
CAT	●	Weight 100H x 30Ø; weighs 0.55kg
CCT	●	Weight 100H x 30Ø; weighs 0.55kg
CCW	●	3m cable; top fitting Ø=16; projects 40 from wall
CD-4	●	W=5; Ø=25
CD-10	●	W=5; Ø=25
CG01	● ●	L=20; Ø=16
CG01-3	● ● ●	L=21; Ø=16
CG02	● ●	L=32; Ø=16
CG03	● ●	L=15; Ø=10
CG03-3	● ● ●	L=15; Ø=10
CG04	● ●	L=22; Ø=10
CG04-3	● ● ●	L=22; Ø=10
CG06	● ●	L=20; Ø=16
CG07	● ●	L=32; Ø=16
CG08	● ●	L=31; Ø=21; 8.5mm Ø hole required 15mm from edge of panel
CG09	● ●	L=22; Ø=16
CG11	● ● ●	L=27; Ø=16
CG11-3	● ● ● ●	L=28; Ø=16
CG12	● ● ●	L=30; Ø=18
CG12-3	● ● ● ●	L=31; Ø=18
CG13	● ● ●	L=27; Ø=18
CG13-3	● ● ● ●	L=28; Ø=18
CG14	● ●	L=20; Ø=20.5
CG14-3	● ● ●	L=21; Ø=20.5
CG15	● ●	L=20; Ø=20.5
CG15-3	● ● ●	L=20.5; Ø=21
CG21	● ● ●	L=46; Ø=16
CG21-3	● ● ● ●	L=46; Ø=16
CG22	● ● ●	L=52; Ø=18
CG22-3	● ● ● ●	L=52; Ø=18
CG23	● ● ●	L=46; Ø=18
CG23-3	● ● ● ●	L=46; Ø=18
CH01	● ●	L=16; Ø=16
CH01-3	● ● ●	L=17; Ø=16
CH02	● ●	L=24; Ø=16
CH02-3	● ● ●	L=24; Ø=16
CQQ	●	2m Cable; top and bottom fitting Ø=16
CS01	●	D=11; Ø=16
CS01-3	● ●	D=11; Ø=16
CS03	● ● ●	L=14; Int Ø=12; Int D=6; Ø=16
CS03-3	● ● ● ●	L=15; Int Ø=12; Int D=6; Ø=16
CS04	● ● ●	L=20; Int Ø=12; Int D=6; Ø=16
CS05	● ● ●	L=14; Ø=16
CS05-3	● ● ● ●	L=15; Ø=16
CS06	● ● ●	L=20; Ø=16
CS07	● ● ●	L=28; Ø=16
CS08	● ● ●	L=12; Ø=12
CS08-3	● ● ● ●	L=16; Ø=16
CS09	● ●	L=17; Ø=16
CS11	● ● ●	L=36; Ø=18
CS11-3	● ● ● ●	L=37; Ø=18
CS12	● ●	H=28; D=14.6; Ø=16

Item code:	Allen key:	Dimensions:
CS12-3	● ●	H=27; D=26; Ø=16
CS13	● ●	L=21.5; Ø=16
CS13-3	● ● ●	L=23.5; Ø=16
CS21	● ● ●	L=64; Ø=16
CS21-3	● ● ● ●	L=64; Ø=16
CS22	● ●	H=28; D=21.2; Ø=16
CS23	● ●	L=35; Ø=16
CS23-3	● ● ●	L=37; Ø=16
CWF	●	3m cable; projects 40 from wall; floor fitting Ø=15
CWW	●	3m cable; projects 40 from wall; fitting plate Ø=38
HDS		D=15; Ø=50
HR10-3	●	L=790; Ø=10
KC2-CG05	● ●	Top fitting Ø=16; support Ø=23
KC2-CG05-10	● ● ●	Top fitting Ø=16;
KMDB/SI	●	H=350; D=350; cables/rods project 40mm & 340mm from wall
KMSB-25/SI		H=30; Ø=35; cable fitting 25mm from wall
KMSB/SI		H=60; Ø=60; cable fitting 50mm from wall
KMSB-100/SI		H=110; Ø=110; cable fitting 100mm from wall
P01		Ø=38
P01-PC01		H=15; Ø=38
P02		Ø=12; D=6
P08	●	H=8; Ø=16
PC01/I		L=12; Ø=16
PC31		L=18
PR01-I		L=12; Ø=16
R1000-10		L=1000; Ø=10
R1000P		L=1000; Ø=6
R1500		L=1500; Ø=6
R1500-10		L=1500; Ø=10
R500		L=500; Ø=6
R500-10		L=500; Ø=10
R500P		L=500; Ø=6
RAAS	● ●	Top fitting Ø=15; bottom fitting Ø=18
RAS	●	Top & bottom fitting Ø=18
RAS-10		Top fitting Ø=20; Bottom fitting Ø=22
RB1		1m rod; top fitting Ø=16
RB2		2m rod; top fitting Ø=16
RB3		3m rod; top fitting Ø=16
RBCF3		3m rod; top fitting Ø=16; bottom fitting Ø=15
RBT1		1m rod; top fitting Ø=16
RBT2		2m rod; top fitting Ø=16
RBT3		3m rod; top fitting Ø=16
RBTf3		3m rod; top fitting Ø=16; bottom fitting Ø=15
RC10-6	●	L=25; Ø=10
REC	●	L=16; Ø=12
REC-10		L=15; Ø=10
REC-P/BL		L=17; Ø=8.5
RG01	● ●	L=25; Ø=16
RG01-10	● ● ●	L=29; Ø=18
RG02	● ●	L=36; Ø=16
RG02-10	● ● ●	L=40; Ø=18
RG05	● ● ●	L=16; Ø=16
RG06	● ● ●	L=25; Ø=16
RG06-10	● ● ● ●	L=29; Ø=18
RG07	● ●	L=36; Ø=16
RG07-10	● ● ●	L=40; Ø=18
RG11	● ● ●	L=30; Ø=16
RG11-10	● ● ● ●	L=34; Ø=18
RG12	● ● ●	L=33; Ø=18
RG12-10	● ● ● ●	L=37; Ø=18
RG13	● ● ●	L=30; Ø=18
RG13-10	● ● ● ●	L=34; Ø=18
RG14-10	● ● ● ●	L=29; Ø=20.5
RG21	● ● ●	L=46; Ø=16
RG21-10	● ● ● ●	L=68; Ø=16
RG22	● ● ●	L=52; Ø=18
RG22-10	● ● ● ●	L=56; Ø=18

Item code:	Allen key:	Dimensions:
RG23	● ●	L=46; Ø=18
RG23-10	● ● ●	L=50; Ø=18
RGN01	● ●	L=25; Ø=16
RH01	● ●	L=19; Ø=16
RH01-10	● ● ●	L=23; Ø=18
RH02	● ●	L=24; Ø=16
RH02-10	● ● ●	L=28; Ø=18
RP	●	Ø=18
RPA	● ● ●	Ø=15
RR01	● ● ●	L=31; Ø=16
RR01-10	● ● ● ●	L=40; Ø=18
RR01-3/10	● ● ● ●	L=33; Ø=18
RR01-3/6	● ● ● ●	L=29; Ø=16
RR01-6/10	● ● ● ●	L=56; Ø=18
RS		Ø=18
RS01	●	D=11; Ø=16
RS03	● ●	L=17.5; Int Ø=12; Int D=6; Ø=16
RS03-10	● ● ●	L=22; Ø=18
RS04	● ● ●	L=21; Int Ø=12; Int D=6; Ø=16
RS04-10	● ● ●	L=26; Ø=18
RS05	● ● ●	L=17; Ø=16
RS05-10	● ● ● ●	L=22; Ø=18
RS06	● ● ●	L=20; Ø=16
RS06-10	● ● ● ●	L=26; Ø=18
RS08	● ● ●	L=18; Ø=16
RS-10	● ●	L=22; Ø=20
RS11	● ● ●	L=39; Ø=16
RS11-10	● ● ● ●	L=43; Ø=18
RS12	● ●	H=28; D=18.1; Ø=16
RS12-10	● ● ●	L=20; Ø=18
RS13	● ● ●	L=25; Ø=16
RS13-10	● ● ● ●	L=30; Ø=18
RS21	● ● ● ●	L=64; Ø=16
RS21-10	● ● ● ● ●	L=68; Ø=18
RS22	● ● ●	L=30; D=24.2; Ø=16
RS23	● ● ●	L=38; Ø=16
RS23-10	● ● ● ●	L=38; Ø=18
RSA	● ●	Ø=15
WM01	● ● ●	L=30
WM02	● ● ●	L=30
WM03	● ● ●	L=16
WM04	● ● ●	L=16
WM05-13	● ● ● ●	L=25; Ø=16
WM05L-20	● ● ● ● ●	L=40; Ø=16
WM06	● ● ●	L=19; Ø=16
WM07	● ● ●	L=28; Ø=16
WM08	● ● ●	L=32; Ø=16
WM09	● ● ● ●	L=31; Ø=16
WM10	● ● ●	L=39; Ø=16; 24mm from wall
WM11	● ● ●	L=31; Ø=16
WM11-10	● ● ● ●	L=36; Ø=18
WM11L-10	● ● ● ● ●	L=59; Ø=18
WM12	● ● ●	L=20; Ø=12
WM15	● ● ●	L=25; Ø=25
WM16	● ● ●	L=50; Ø=25
WM17	● ● ●	L=75; Ø=25
WM18	● ● ●	L=25; Ø=16
WM19	● ● ●	Ø=16
WM20	● ● ●	Ø=25; D=5.5
WMS-2	● ● ●	D=2
WMS-3	● ● ●	D=3

ALLEN KEYS:
To see which allen key each component requires, check the colour code in the list above against the grid below:

AK1.5	1.5mm	●
AK2.0	2.0mm	●
AK2.5	2.5mm	●
AK3.0	3.0mm	●
AK4.0	4.0mm	●
AK5.0	5.0mm	●
AK6.0	6.0mm	●

create the perfect display for

Wall mounted...



Signage suspended from the ceiling...



Floor-to-ceiling creativity...



Versatile cable and rod systems that allow you to create exactly the display you want.

you...

Freestanding displays

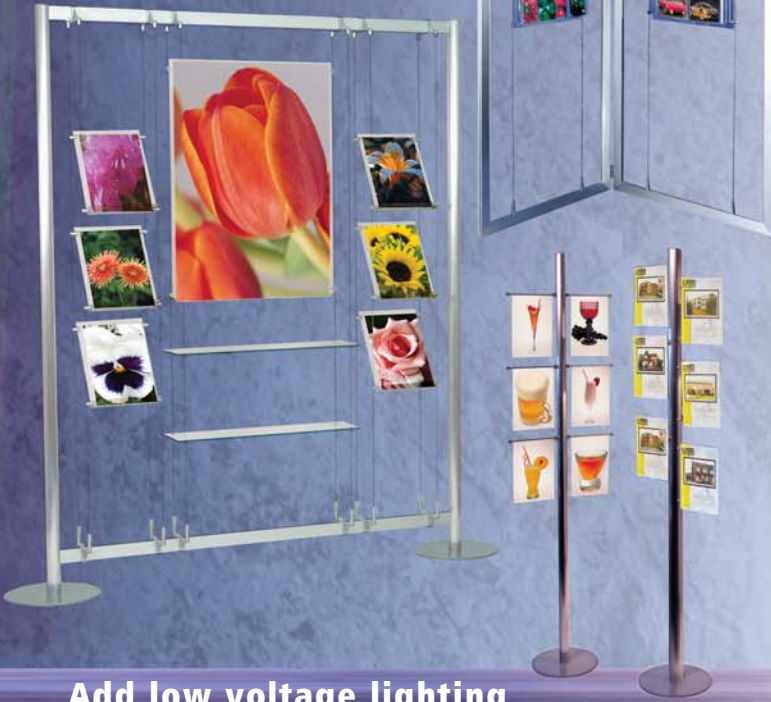

Add low voltage lighting



Add movement...

and watch your sales increase



Floating multi-media presentations...



The very latest digital displays will add sound and movement to your displays...and increase sales too...

Add flexibility to your display with channel...



Incredibly slim, bright light boxes create maximum impact...



Ultra-bright, slim light boxes can be suspended or wall mounted... used on their own or combined with other displays...

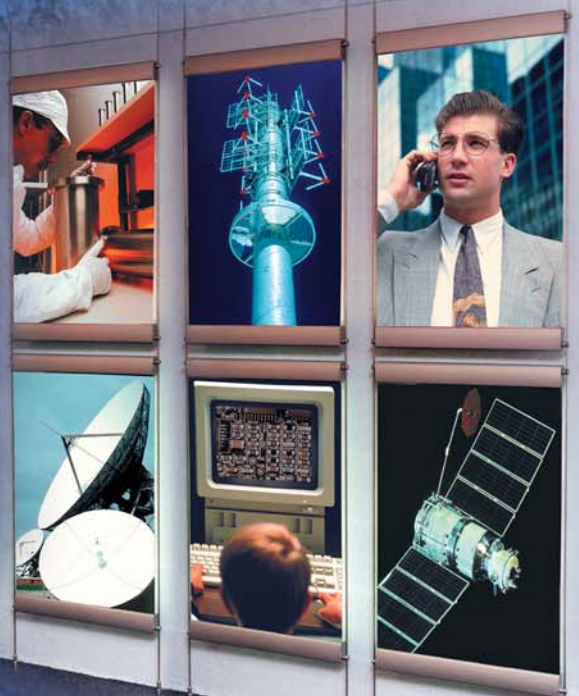



DISPLAY EXHIBITION
& SHOP EQUIPMENT

John Ellis Shop Equipment Limited

TEL: 01223 892283 FAX: 01223 891572

johnellis@shopequip.co.uk

www.shopequip.co.uk